



Drawing No.	:- TPC325
Issue	:- 2
Date	:- 23/10/08

**EBAC MODEL PD120
INDUSTRIAL DEHUMIDIFIER
OWNER'S MANUAL**

Ebac Industrial Products, Inc.
700 Thimble Shoals Blvd, Suite 109
Newport News, VA. 23606-2575
Tel: (757) 873 6800 Fax: (757) 873 3632
Website www.ebacusa.com

UNPACKING

Carefully remove the PD120 dehumidifier unit from its transit box and visually check for signs of transit damage. If there is evidence of damage DO NOT attempt to operate the unit, call your supplier for advice. Do not discard the packing, it will be useful when transporting the dehumidifier unit in the future.

INTRODUCTION

The Ebac PD120 industrial dehumidifier removes moisture from the air through the refrigeration process.

The Ebac PD120 is basically comprised of:

- 1) A compressor
- 2) A refrigerant evaporator coil
- 3) A refrigerant condenser coil
- 4) One circulation fan
- 5) A remote humidistat
- 6) A cabinet to house the above components

The fan draws the moist air through the cold evaporator coil which cools the air below its dew point. Moisture forms on the evaporator coil and is collected in the condensate tray which is equipped with a permanent drain. The cooled air then passes through the hot condenser coil where it is reheated using the same energy removed during the cooling phase, plus the additional heat generated by the compressor. The air is therefore discharged from the dehumidifier at a slightly higher temperature with a lower absolute humidity than with which it entered. Continuous circulation of air through the dehumidifier gradually reduces the relative humidity within the area.

The PD120 dehumidifier is a rugged, reliable drying unit designed to operate effectively over a broad range of temperature and humidity conditions.

The PD120 dehumidifier uses a remotely mounted adjustable humidistat to enable you to select the level of dryness.

SPECIFICATIONS

MODEL:	Ebac PD120
HEIGHT:	18"
WIDTH:	27.2"
DEPTH:	26.4"
WEIGHT:	155 lbs
AIRFLOW:	Low 265 CFM High 500 CFM
HORSEPOWER:	1.5
POWER SUPPLY:	110V-115V/60Hz/1ph
FINISH:	Powder-coated Epoxy
REFRIGERANT TYPE/QTY:	R22

INSTALLATION

POSITIONING:

Position the dehumidifier unit in the center of the room to be conditioned if at all possible. However if a damp patch is particularly apparent the outlet grille should be pointed towards it if possible.

This unit can also be used in a duct system where applicable, please see the diagrams on the following pages which identify the overall sizes of the unit and also the mounting points.

NOTE: Both inlet grille and outlet grille of the dehumidifier unit must have clear space around them and not be obstructed in anyway.

Before connecting this unit to the relevant power supply the following must be carried out.

Selecting the correct fan speed – The PD120 has a low fan speed and a high fan speed and the required speed must be chosen before installation. To select the correct fan speed firstly remove the air inlet cover via the 10off M4 hex head bolts, then remove the electrical box cover via the 4off M4 hex head bolts. Once the electrical box cover is removed the supplied link wire must be wired between either the ‘C’ and ‘L’ or the ‘C’ and ‘H’ terminals on the terminal block. This is shown below.

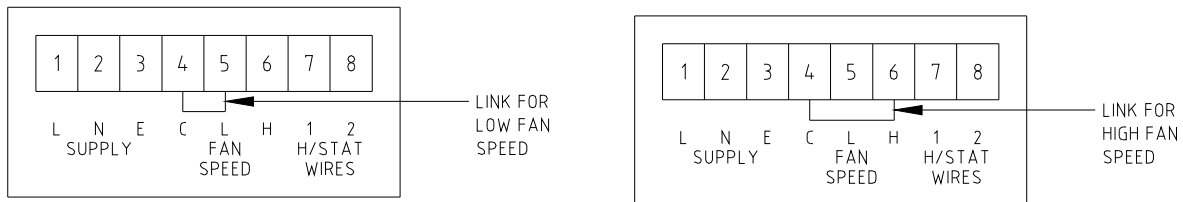

Before the unit will switch on it must have a low voltage humidistat wired into it with the NC contacts wired to the terminal block inside the electrical box as shown below.

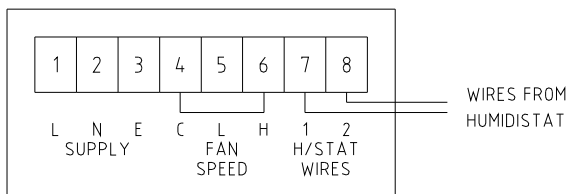

OPERATION

The following procedures should be followed to test the PD120 for correct operation:

- 1) After unpacking, examine all external features to confirm damage-free shipment. Report all defects and damage at once. Connect the power cable to a grounded power source.
- 2) Install drain tubing as required.

Caution: Do not operate the machine without the covers for any longer than necessary. Do not remove/ replace the covers when the unit is in operation.

Check dehumidification process as follows:

- A. Place unit on a level surface.
- B. Start up unit as follows:
 - i. Ensure fan speed selection has been chosen as mentioned in previous pages and also that the humidistat has been wired in.
 - ii. Rotate humidistat control knob to fully counter clockwise, minimum setting.
 - iii. Plug unit into power supply and rotate humidistat knob clockwise to desired setting.
- C. Check that the compressor is running.
- D. Leave the machine running for 15 minutes.
- E. Observe the evaporator coils behind the filter on the air inlet end of the unit to confirm frost formation.
 - i. If the air temperature is below 70°F, an even coating of frost should cover the entire evaporator coil, except for the last one or two coils.
 - ii. If the air temperature is about 70°F, frost and/or droplets of condensed water should cover the entire evaporator coil.
- F. As the drain tray fills, the condensate will automatically drain by gravity.

If after carrying out the above procedures, the unit does not appear to function properly, refer to the Trouble Shooting section or contact the Factory Service Center.

WARNING:

- Due to the high pressures within the refrigeration circuit, under no circumstances must direct heat be applied to the evaporator coil in an attempt to remove the build up of ice.
- No attempt should be made to cut open any part of the refrigeration circuit due to high pressures and gas involved. If the unit is switched off at the mains power supply for any reason, the unit must be allowed to stand at rest for at least five minutes before restarting. Failure to do so may cause the unit to blow the fuses owing to the compressor due to there being a refrigerant imbalance.

ROUTINE MAINTENANCE

WARNING: ENSURE THAT THE POWER CORD TO THE MACHINE HAS BEEN DISCONNECTED BEFORE CARRYING OUT ROUTINE MAINTENANCE ON ITEMS 1, 2, 4, 5, AND 6.

To ensure continued full efficiency of the dehumidifier, maintenance procedures should be performed as follows:

1. Clean the surface of the evaporator and condenser coils by blowing the dirt out from behind the fins with compressed air. Hold the nozzle of the air hose away from the coil (approx 6") to avoid damaging the fins. Alternatively, vacuum clean the coils.

WARNING: DO NOT STEAM CLEAN REFRIGERATION COILS.

2. Check that the fan is firmly secured to the motor shaft and that the fan rotates freely. **The fan motor is sealed for life and therefore does not need oiling.**
3. To check the refrigerant charge, run the unit for 15 minutes and briefly remove the cover. The evaporator coil should be evenly frost coated across its surface. At temperatures above 70°F, the coil may be covered with droplets of water rather than frost. Partial frosting accompanied by frosting of the thin capillary tubes, indicates loss of refrigerant gas or low charge.
4. Check all wiring connections.

IF ANY OF THE PRECEDING PROBLEMS OCCUR, CONTACT THE EBAC SERVICE CENTER PRIOR TO CONTINUED OPERATION OF THE UNIT TO PREVENT PERMANENT DAMAGE.

REPAIRS

1. Should an electrical component fail, consult the Factory Service Center to obtain the proper replacement part.
2. If refrigerant gas is lost from the machine, it will be necessary to use a refrigeration technician to correct the fault. Contact the Factory Service Center prior to initiating this action.

Any competent refrigeration technician will be able to service the equipment. The following procedure must be used:

- a. The source of the leak must be determined and corrected.
- b. The machine should be thoroughly evacuated before recharging.
- c. The unit must be recharged with refrigerant measured accurately by weight.
- d. For evacuation and recharging of the machine, use the crimped and brazed charging stub attached to the side of the refrigerant compressor.

The charging stub should be crimped and rebrazed after servicing. **NEVER** allow permanent service valves to be fitted to any part of the circuit. Service valves may leak causing further loss of refrigerant gas.

3. The refrigerant compressor fitted to the dehumidifier is a durable unit that should give many years of service. Compressor failure can result from the machine losing its refrigerant gas. The compressor can be replaced by a competent refrigeration technician.

Failure of the compressor can be confirmed by the following procedure:

- a. Establish that power is present at the compressor terminals using a voltmeter.
- b. With the power disconnected, check the continuity of the internal winding by using meter across the compressor terminals. An open circuit indicates that the compressor should be replaced.
- c. Check that the compressor is not grounded by establishing that a circuit does not exist between the compressor terminals and the shell of the compressor.



TROUBLESHOOTING

<u>SYMPTOM</u>	<u>CAUSE</u>	<u>REMEDY</u>
Unit inoperative	1. no power to unit	1. Check the power from the power supply panel
Little or no airflow	1. Loose fan on shaft 2. Fan motor burnt out 3. Dirty refrigeration coils 4. Loose electrical wiring 5. Fuse blown or circuit breaker tripped	1. Tighten fan 2. Replace the fan motor 3. See <i>Routine Maintenance</i> Section 4. Check the wiring diagram to find fault and repair 5. Replace the fuse or reset the circuit breaker
Little or no water extraction	1. Insufficient air flow 2. Compressor fault 3. Loss of refrigerant gas	1. Check all of the above 2. Contact the Factory Service Center 3. Contact the Factory Service Center
Unit vibrates excessively	1. Loose compressor mounts 2. Damaged fan	1. Tighten the nuts on the compressor mounts 2. Replace fan
Water flooding inside the machine	1. Drain pipe blocked/frozen 2. Drain pipe too high	1. Clear the obstruction 2. Ensure that no section of the drain hose is above the level of the water outlet

Ebac Industrial Products, Inc.
 700 Thimble Shoals Blvd, Suite 109
 Newport News, VA. 23606-2575
 Tel: (757) 873 6800 Fax: (757) 873 3632
 Website www.ebacusa.com



Drawing No.	:- TPC325
Issue	:- 2
Date	:- 23/10/08

RATING PLATE INFORMATION

	PD120
MOISTURE REMOVAL (PINTS PER 24 HOURS) @ 80F / 60% RH:	107
REFRIGERANT:	1300 Grams
VOLTAGE:	115 Volts
POWER:	1.1 KW
PHASE:	Single
HZ:	60 Hz
CURRENT:	10 A
CONTROL VOLTAGE:	5 V DC
TIME DELAY FUSE:	15 A



Drawing No.	:- TPC325
Issue	:- 2
Date	:- 23/10/08

LIMITED WARRANTY

Our products carry a one-year unconditional warranty against any defects in workmanship or material. This warranty will cover all parts and labor required to repair your Ebac product. This warranty is invalid if the unit has been abused, damaged, whether intentional or accidental, or if any modifications have been made to the unit.

THE FOREGOING WARRANTY IS EXCLUSIVE AND IS ISSUED IN LIEU OF ALL OTHER WARRANTIES (WHETHER WRITTEN, ORAL, OR IMPLIED) INCLUDING THE WARRANTY OF MERCHANTABILITY AND THE WARRANTY OF FITNESS FOR A PARTICULAR PURPOSE. EBAC INDUSTRIAL PRODUCTS, INC. DISCLAIMS ANY LIABILITY FOR CONSEQUENTIAL DAMAGES, LOST PROFITS, OR INCIDENTAL DAMAGES FOR BREACH OF ANY WRITTEN OR IMPLIED WARRANTY WITH RESPECT TO THE FOREGOING DESCRIBED MERCHANDISE.

For Your Records: Model: _____
 S/N: _____
 Date Received: _____

SAVE THIS SECTION FOR YOUR RECORDS

CLIP AND RETURN THIS CARD

PLEASE NOTE

To ensure that your Ebac Dehumidifier is accorded the full coverage provided by this warranty, please complete and mail this card at your earliest convenience.

Thank You

WARRANTY REGISTRATION

MODEL _____	S/N _____	DATE RECEIVED _____
OWNER _____		
ADDRESS _____		
CITY _____	STATE _____	ZIP _____
COMMENTS _____		

Ebac Industrial Products.
700 Thimble Shoals Boulevard, Suite 109, Newport News, Virginia. 23606-2575

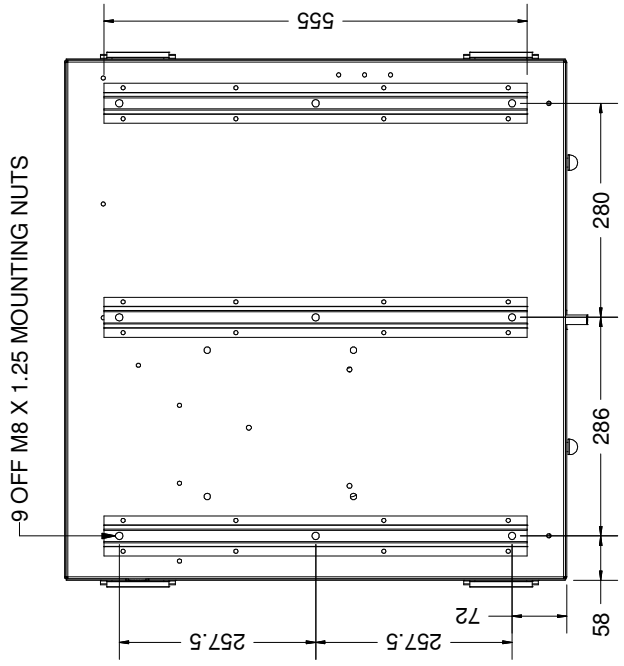
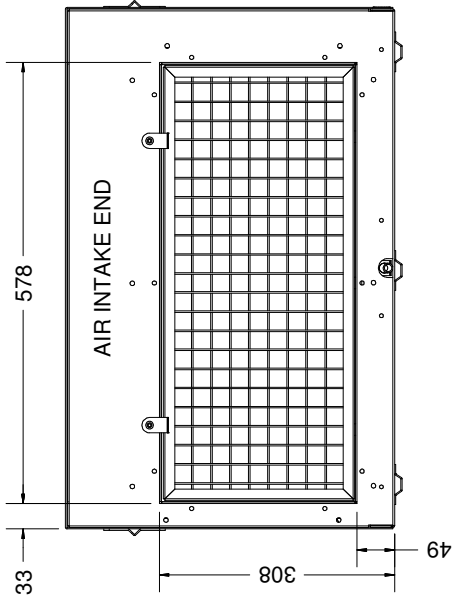
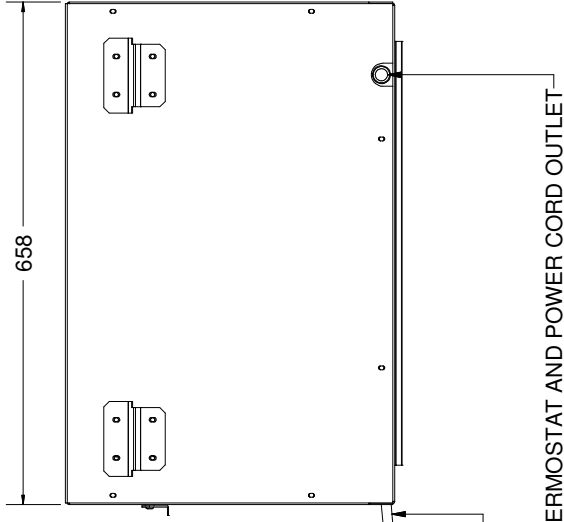
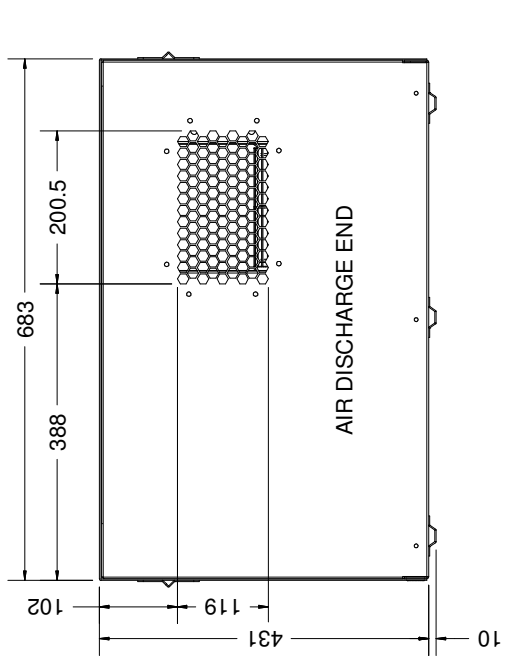



The above diagrams show the overall sizes of the unit, the positioning of the air inlet aperture, the positioning of the air discharge aperture and the M8 mounting points on the base of the unit.

Once the unit is in the desired location a 1/2" flexible pipe must be connected to the condensate drainage outlet which is positioned under the air inlet aperture as shown above. This should then be used to drain away condensate water into a permanent drain or a water collection container.

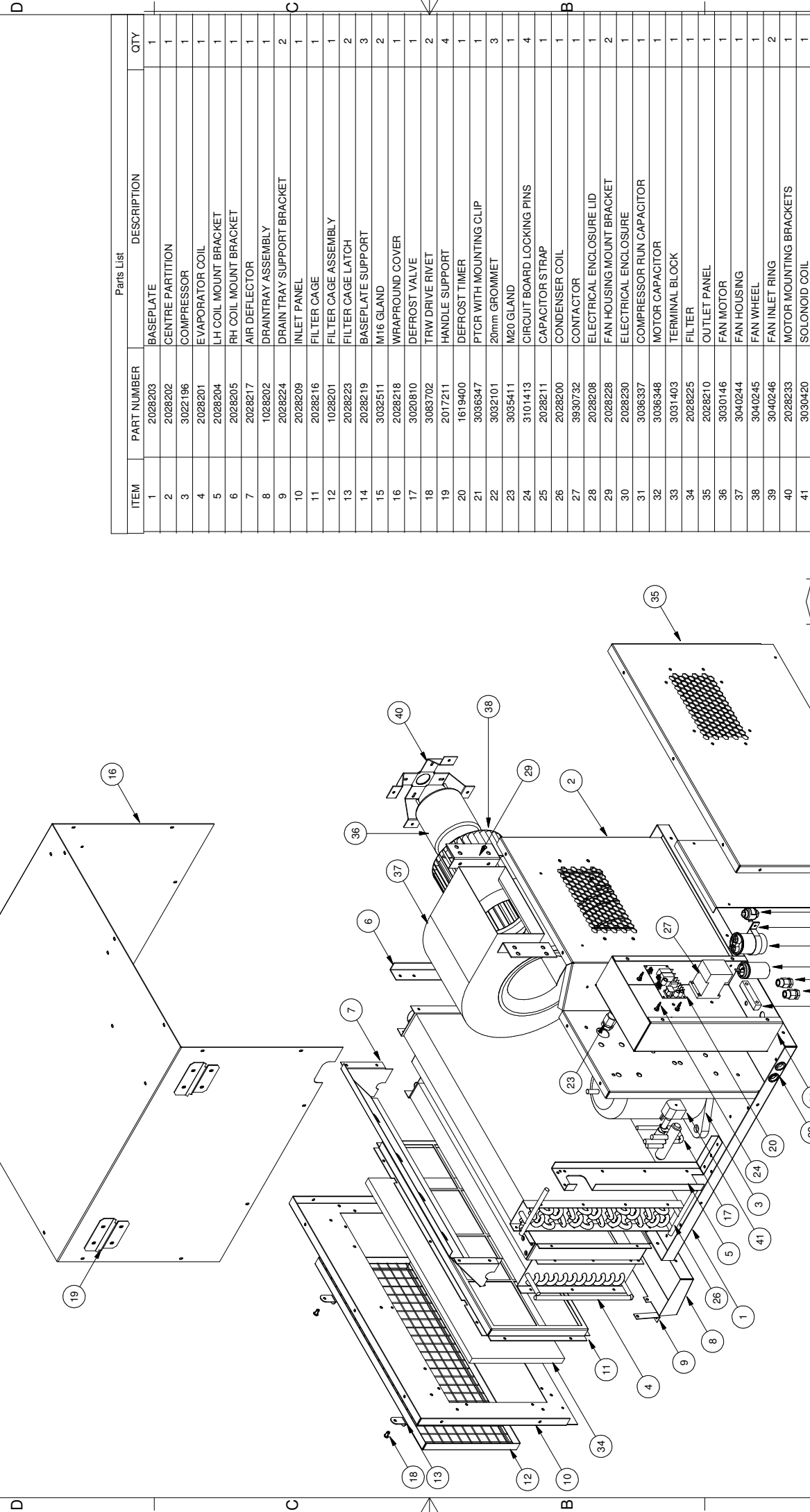
3	2	1
ISS.	DATE	COMMENTS
1	20/08/08	ORIGINAL
2	06/02/09	CONTACTOR PART NUMBER CORRECTED - WDA



 LIMITED BISHOP AUCKLAND ENGLAND		TITLE PD120 EXPDED VIEW	
DIMENSIONS IN m.m. TOLERANCES UNLESS OTHERWISE STATED 0 ± 1 0.0 ± 0.25 0.00 ± 0.05 ANGULAR ± 0.5 DEGREE		MATERIAL N/A	
3RD ANGLE PROJECTION  DO NOT SCALE IF IN DOUBT ASK		FINISH N/A	
DRAWN : W DAGLISH CAD SCALE : 1/10		DRG.NO. 1028200	
SHEET 1 of 1		2	

Parts List			
ITEM	PART NUMBER	DESCRIPTION	QTY
1	2028203	BASEPLATE	1
2	2028202	CENTRE PARTITION	1
3	3022196	COMPRESSOR	1
4	2028201	EVAPORATOR COIL	1
5	2028204	LH COIL MOUNT BRACKET	1
6	2028205	RH COIL MOUNT BRACKET	1
7	2028217	AIR DEFLECTOR	1
8	1028202	DRAINTRAY ASSEMBLY	1
9	2028224	DRAIN TRAY SUPPORT BRACKET	2
10	2028209	INLET PANEL	1
11	2028216	FILTER CAGE	1
12	1028201	FILTER CAGE ASSEMBLY	1
13	2028223	FILTER CAGE LATCH	2
14	2028219	BASEPLATE SUPPORT	3
15	3032511	M16 GLAND	2
16	2028218	WRAPROUND COVER	1
17	3020810	DEFROST VALVE	1
18	3083702	TRW DRIVE RIVET	2
19	2017211	HANDLE SUPPORT	4
20	1619400	DEFROST TIMER	1
21	3036347	PTCR WITH MOUNTING CLIP	1
22	3032101	20mm GROMMET	3
23	3035411	M20 GLAND	1
24	3101413	CIRCUIT BOARD LOCKING PINS	4
25	2028211	CAPACITOR STRAP	1
26	2028200	CONDENSER COIL	1
27	3930732	CONTACTOR	1
28	2028208	ELECTRICAL ENCLOSURE LID	1
29	2028228	FAN HOUSING MOUNT BRACKET	2
30	2028230	ELECTRICAL ENCLOSURE	1
31	3036337	COMPRESSOR RUN CAPACITOR	1
32	3036348	MOTOR CAPACITOR	1
33	3031403	TERMINAL BLOCK	1
34	2028225	FILTER	1
35	2028210	OUTLET PANEL	1
36	3030146	FAN MOTOR	1
37	3040244	FAN HOUSING	1
38	3040245	FAN WHEEL	1
39	3040246	FAN INLET RING	2
40	2028233	MOTOR MOUNTING BRACKETS	1
41	3030420	SOLONOID COIL	1

ISSUE	DATE	AMENDMENTS
1	30/6/06	ORIGINAL
2	06/02/08	EARTHS ADDED - WDA
3	09/04/08	H/STAT & SENSOR WIRES ADDED - WDA
4	24/07/08	CAPACITOR VALUES ADDED - WDA

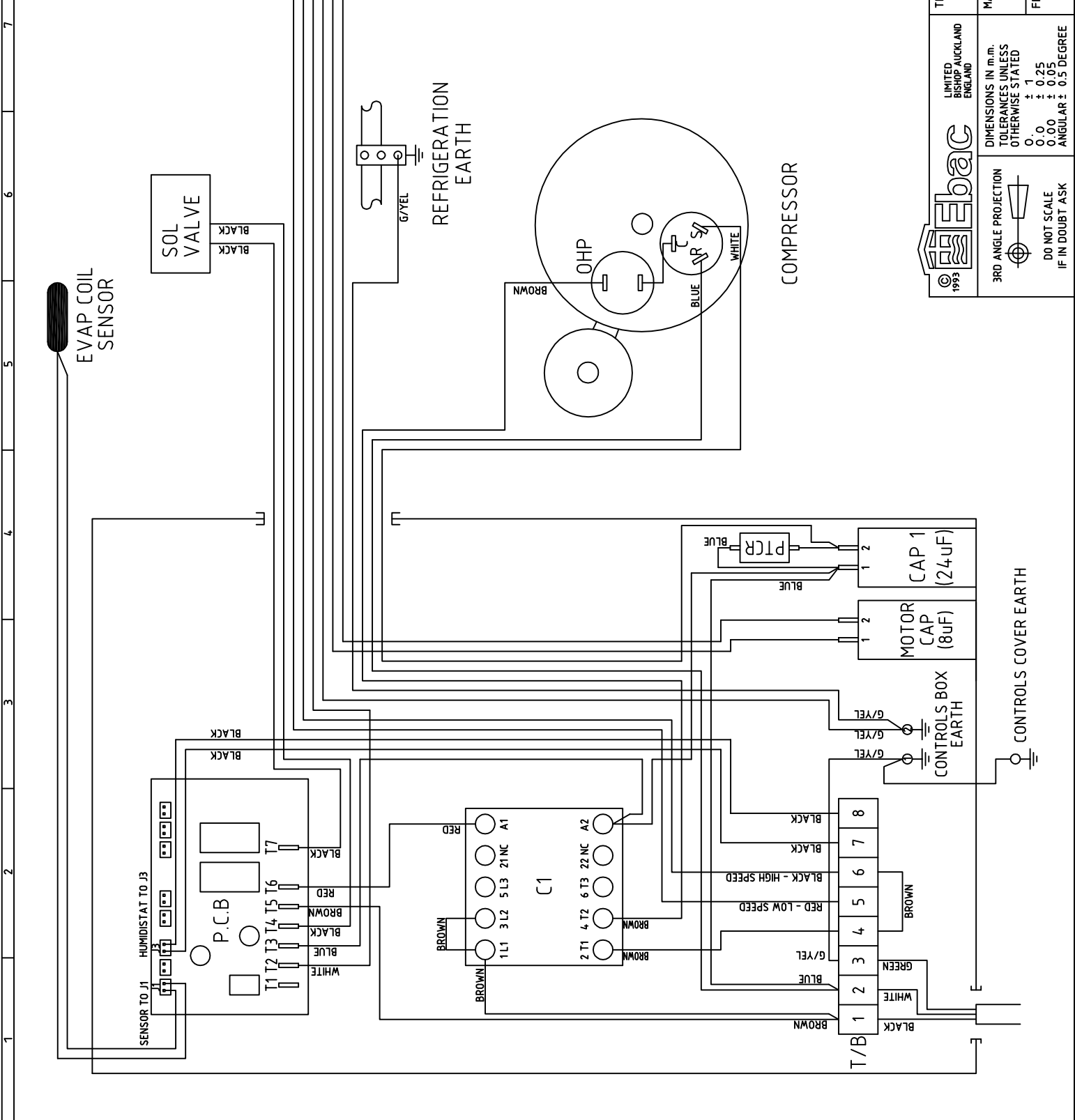

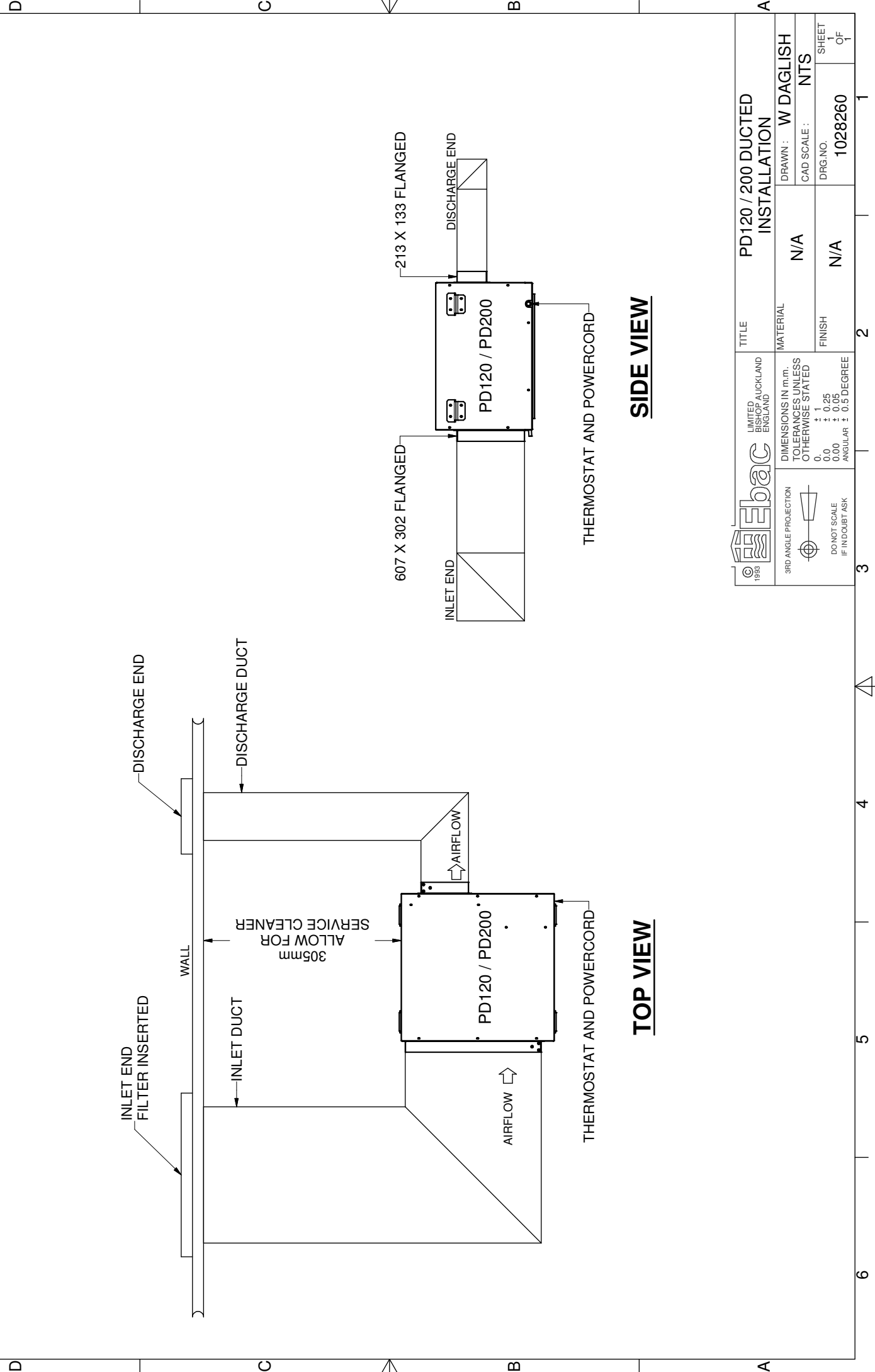

TITLE	PD120 WIRING DIAGRAM	
MATERIAL	N/A	DRAWN : W DAGLISH
DIMENSIONS IN m.m.	TOLERANCES UNLESS OTHERWISE STATED	
0.0	± 0.25	
0.00	± 0.05	
ANGULAR	± 0.5 DEGREE	
3RD ANGLE PROJECTION		
DO NOT SCALE	IF IN DOUBT ASK	
FINISH	N/A	DRG.NO. 5016181
CAD SCALE	N/A	SHEET 1 OF 1

3	2	1
ISS.	DATE	COMMENTS
1	23/10/08	ORIGINAL



SIDE VIEW

TOP VIEW

 LIMITED BISHOP AUCKLAND ENGLAND		TITLE PD120 / 200 DUCTED INSTALLATION	
DIMENSIONS IN m.m. TOLERANCES UNLESS OTHERWISE STATED ± 1 0.0 ± 0.25 0.00 ± 0.05 ANGULAR ± 0.5 DEGREE		MATERIAL N/A	
3RD ANGLE PROJECTION  DO NOT SCALE IF IN DOUBT ASK		DRAWN: W DGLISH CAD SCALE: NTS	
		FINISH N/A	
		DRG.NO: 1028260	
		SHEET OF 1	