

ASPIRADORAS

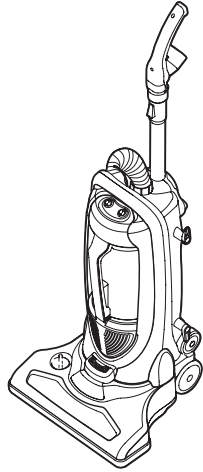

USE & CARE INSTRUCTIONS



**Aspiradora Vertical y de Canastilla
2 en 1 con Tecnología limpia de plata**
Modelo No. GGU300

La aspiradora sin bolsa 2 en 1 es una aspiradora vertical Y de canastilla. Use la poderosa aspiradora vertical para limpiar alfombras y pisos descubiertos, luego convierta rápidamente la aspiradora al modo de canastilla para limpiar las escaleras y otras áreas difíciles de alcanzar.

Modelo No. FLTB Filtro HEPA de Repuesto del Recipiente de Polvo
Modelo No. FLTA Filtro de Descarga de Repuesto
Modelo No. BLT1 Banda de Repuesto

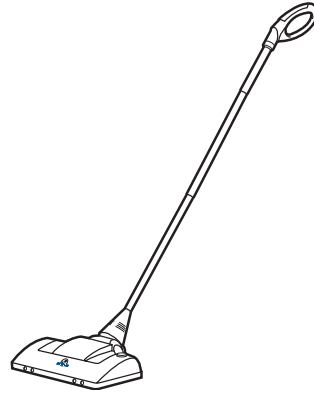

Barredora Ligera UV-C
Modelo No. GGLSW11

Debido al diseño liviano y el poder de limpieza sin cordón, la barredora ligera UV-C facilita y agiliza la eliminación de la suciedad. La tecnología de luz UV-C de la base permite eliminar los gérmenes en el piso mientras barre.

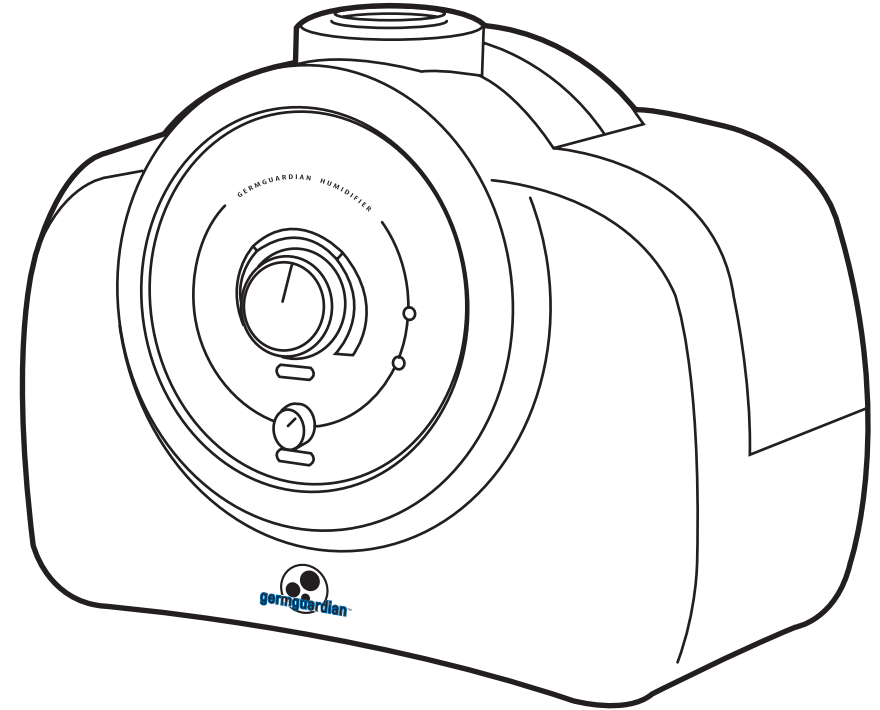

Germ Guardian® Ultrasonic Humidifier



**Clear® Desinfectante de Aire UV-C
Recargable + Aspiradora de Mano**
Modelo No. GGH200

La luz UV-C en la base de carga funciona continuamente para eliminar el 99.9% de gérmenes suspendidos en el aire, los olores y los alérgenos mientras se carga la aspiradora.

Modelo No. FLTF Filtro de Repuesto del Recipiente de Polvo
Foco de Repuesto para el Modelo No. LB1000

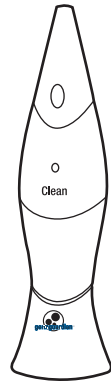

Aspiradora de Mano Recargable
Modelo No. GGH100

La tecnología limpia de plata en el recipiente de polvo evita la proliferación de bacterias y moho que provocan malos olores. La aspiradora se guarda en la base para que esté siempre cargada y lista para limpiar rápidamente la suciedad seca.

Modelo No. FLTF Filtro de Repuesto del Recipiente de Polvo

Model No. H2000
3-Year Limited Warranty
www.germguardian.com
1.866.603.5900

English E - 1
French F - 1
Spanish S - 1

Date Purchased
month _____
year _____

E-1

READ AND SAVE THIS MANUAL PRODUCT SPECIFICATIONS AND PARTS

SPECIFICATIONS

Model Number: H2000
Humidifying Mode: Combination
Power Supply: AC120V, 60Hz
Power Consumption: 140W (40W at cold humidification)
Maximum Humidity Capacity: About 350cc/Hr (at highest setting and warm humidification)
Tank Capacity: 1.4 gallons
Successive Humidity Hours: Up to approximately 72 hours depending on environmental conditions
Dimensions: Width - 14.5 inches; Length - 9 inches; Height - 12 inches
Weight: 6 pounds (not including packaging)

PARTS

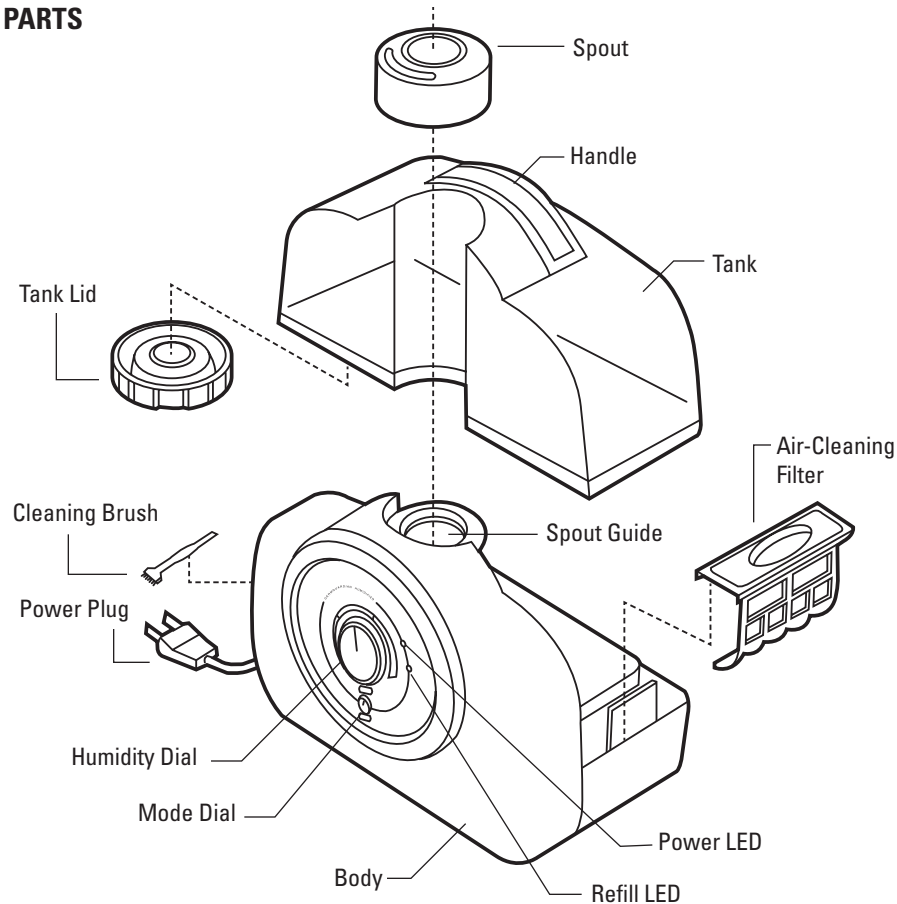

FUNCTIONS AND FEATURES

Warm or Cold Humidification Selection

Select humidifying temperature based on need. Warm humidity will use more power but will humidify your room quicker.

Water Shortage Indicator

When the unit is low on water the Refill LED on the front panel will light up, and the unit will shut off. Simply add more water to continue use.

Humidity Adjustment

The humidity volume may be adjusted based on need by using the adjustment knob on the front panel.

Silver Clean Technology

Small silver particles have been added to the water tank to help fight the growth of bacteria and mold.

WARNINGS



This product should be used only in accordance with the specifications outlined in this manual. Usage other than what has been specified here may result in serious injury.

WARNING: THE CORDS, WIRES, AND/OR CABLES SUPPLIED WITH THIS PRODUCT CONTAIN CHEMICALS, INCLUDING LEAD OR LEAD COMPOUNDS, KNOWN TO THE STATE OF CALIFORNIA TO CAUSE CANCER AND BIRTH DEFECTS OR OTHER REPRODUCTIVE HARM, WASH HANDS AFTER USING.

- Disassembly, repair or remodeling by an unauthorized person may result in serious harm.
- Do not use if plug is damaged or loose.
- Keep this product out of the reach of children and pets.
- Be careful not to put water in the humidity spout.
- Before filling or cleaning the unit, make sure it is unplugged.
- Once the humidifier has been turned on, do not move it.
- Do not remove the water tank from the unit while it is on.
- Do not handle the plug with wet hands.
- Do not excessively bend, twist or pull the power cord.
- Avoid placing this product where the humidity spout is pointed directly at an object.
- Do not inhale the humidity spout.
- Do not place this product on a sloped or unstable surface.
- When not in use, unplug the unit.
- Do not fill the water tank with hot or boiling water.
- Do not use this product in direct sunlight or near a gas stove or heater.
- If the water tank becomes cracked or damaged do not use.
- Do not keep this product running for an extended period of time.
- Do not clean the unit of water tank with detergents or chemicals of any kind.
- Do not use this product near any other electronic device.
- Do not cover the humidity opening at any time during use.
- Do not use this product near a sink.
- Do not drink water from tank.
- Do not place this product on an absorbent surface.

Failure to comply with the warnings listed above may result in electric shock or serious injury.

DIRECTIONS FOR USE

Make sure the unit is unplugged.

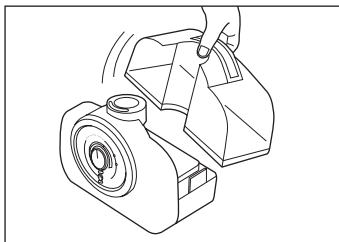

1. Separate the tank from the body of the unit.

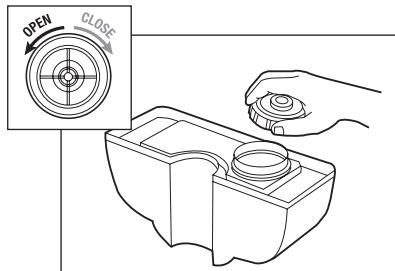

2. Open the tank lid, turning it to the left.

DIRECTIONS FOR USE

(Continued)

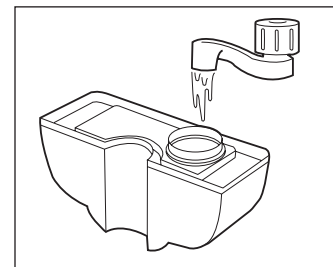

3. Pour cool, clean water directly into the tank.

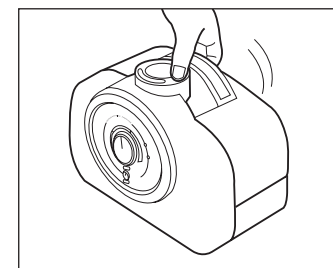

5. Attach the tank to the body of the unit and plug in.

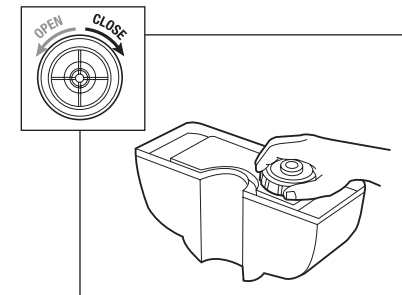

4. Close the tank lid, turning it to the right.

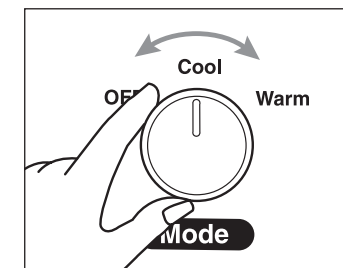

6. Turn the Mode Dial to either cool or warm. The Power LED light up.

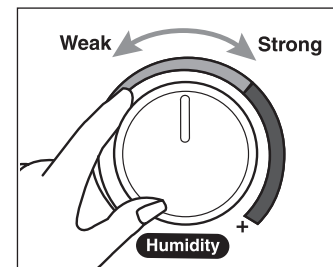

7. Turn the Humidity Dial to the desired volume of humidity. Toward the right and the humidity level increases; toward the left and the humidity level decreases.

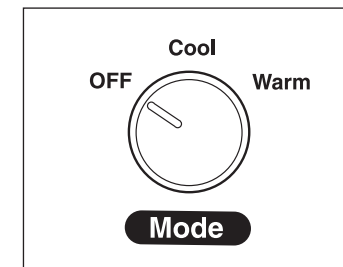

8. As soon as the Refill LED lights up, turn the unit off and refill the water tank.

MAINTENANCE

- Always unplug the unit before servicing it in any way.
- The water temperature of the water remaining in the unit after use may be high.
- Do not submerge the unit in the water, or allow water to enter the inside of the unit.

INSIDE THE BODY OF THE UNIT

Pour excess water out of the unit, but do not allow it to enter the blast port. Wash out the unit with fresh water, using the cleaning brush and a soft cloth as needed.

OUTER SURFACE OF THE UNIT

Wipe the surface of the unit with a soft damp cloth if needed.

WATER TANK

If water spots remain in the water tank, wipe the inside down with a soft cloth. Do not use soap or detergents.

AIR FILTER

Gently wipe away debris from the filter with a soft cloth.

ULTRASONIC DISK

Remove spray spout (Fig. 1) and use the enclosed cleaning brush to regularly remove build up and deposits from this area (Fig. 2). White vinegar will help to prevent this build up.

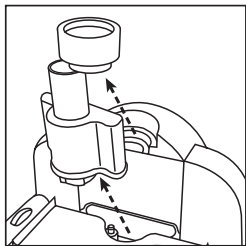

(Fig. 1)

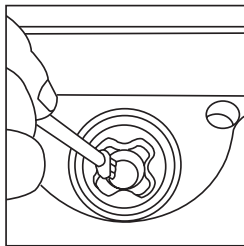

(Fig. 2)

STORAGE

- Fully dry the inside and outside of the unit before storing it.
- DO NOT leave water in the unit.
- Store in a cool, dry place.

TROUBLESHOOTING GUIDE

PROBLEM	SOLUTION
Water vapor & humidity are not produced.	Power Plug: Unplug and then try again. Power Failure: When the power is returned, try again. Bucket Installation: Make sure the bucket is correctly attached.
Air blows but water vapor is not produced.	Excessive Water: Remove a certain amount of water from the bucket. The desired humidity is lower than the current temperature: Increase the desired humidity. Detergent residue in bucket: Wash the bucket out and try again.
Humidity level is low.	The surface of the vibrator is dirty: Clean the vibrator. The water in the unit is too cold: Replace with cool, but not cold water. Damage on the vibrator: Exchange the vibrator.
Warm humidity is not produced.	It may take 10-15 minutes before warm humidity is created.
The humidity has a bad smell.	Poor maintenance or dirty water: Clean the product thoroughly, and fill it with fresh water.
White dust is forming on nearby furniture.	Hard water may deposit a certain amount of dust. Dust in the air also settles because of added humidity in the room. Use distilled water if this becomes a nuisance.

LIMITED WARRANTY

To the consumer, Guardian Technologies LLC warrants this product to be free of defects in materials or workmanship commencing upon the date of the original purchase. Save your original sales receipt to validate start of warranty period.

If this product should become defective within the warranty period, we will repair or replace any defective parts free of charge. The complete machine must be delivered pre-paid to any authorized Guardian Technologies LLC warranty service center. Please include complete information on the problem, day of purchase, copy of original sales receipt and your name, address and telephone number. If you are not near a warranty station, call the factory for assistance in the US and Canada at 1.866.603.5900. Use only genuine Guardian Technologies replacement parts.

The warranty does not include unusual wear, damage resulting from accident, or unreasonable use of the product. This warranty does not cover unauthorized repairs. This warranty gives you specific legal rights and you may also have other rights (other rights may vary from state to state in the U.S.A.).

We consider the registration process important to ensuring superior service to our customers, however submitting this card to Guardian Technologies LLC is optional and does not affect your rights to utilize this warranty according to the conditions stated above. If you have any questions or comments about our product call toll free at: **1.866.603.5900**, or send comments to:

**ATTN: Customer Service
Guardian Technologies LLC
7700 St. Clair Avenue
Mentor, Ohio 44060**

Guardian Technologies LLC
7700 St Clair Avenue | Mentor, Ohio 44060
1.866.603.5900 | www.germguardian.com

Additional Products Available from Germ Guardian®

UV-C SANITIZERS

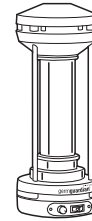

UV-C Room Air Sanitizer
Model No. EV9102



Pluggable UV-C Air Sanitizer
Model No. GG1000

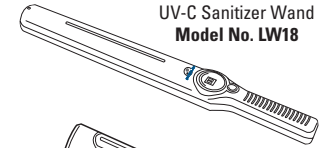

UV-C Sanitizer Wand
Model No. LW18

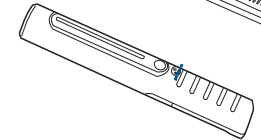

UV-C Mini Sanitizer Wand
Model No. LW9

HEAT SANITIZERS

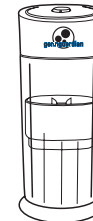

Toothbrush Sanitizer
Model No. TS3000

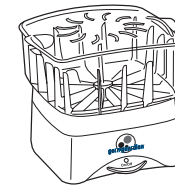

Dry Heat
Nursery Sanitizer
Model No. NS2000

AIR CLEANSING SYSTEMS

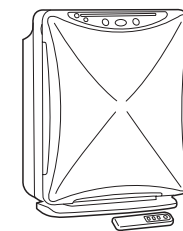

Complete Air Cleansing System
Model No. AC6000

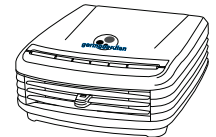
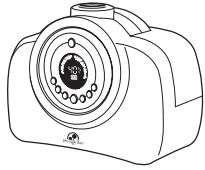

Table Top Complete
Air Cleansing System
Model No. AC4000

Additional Products Available from Germ Guardian®

HUMIDIFIERS



Ultrasonic Digital Humidifier
with Silver Clean Technology
Model No. H3000 & H3010

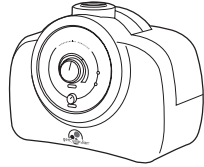

Ultrasonic Humidifier
with Silver Clean Technology
Model No. H2000 & H2000B

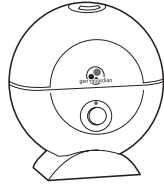

Ultrasonic Table Top
Humidifier with
Silver Clean Technology
Model No. H1000

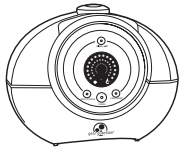

Ultrasonic Digital Humidifier
with Silver Clean Technology
Model No. H1600

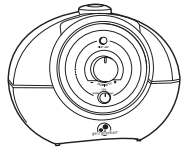

Ultrasonic Humidifier
with Silver Clean Technology
Model No. H1500

VACUUMS

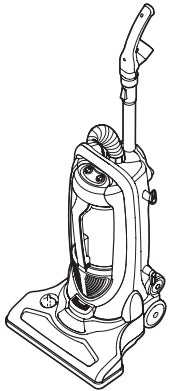

2-in-1 Upright & Canister
with Silver Clean Technology
Model No. GGU300



Clean² Rechargeable
UV-C Air Sanitizer + Hand Vac
Model No. GGH200

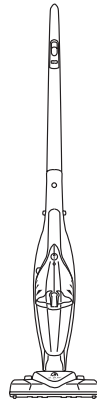

2-in-1 Stick Vac and Hand Vac
with Silver Clean Technology
Model No. GGS50