

NES210 series

Stick vacuum cleaner; household type

Owner's Guide

Thank you for purchasing your new Eureka vacuum!

Important instructions

For easy assembly, please take a few moments to read this owner's guide.

If you have questions about your new vacuum, please contact our customer service HELPLINE at **1-800-282-2886**. *We're here to help!*



Eureka stands by our Clean Promise seal.
Learn more at www.eureka.com/cleanpromise

www.eureka.com



eureka®

Where to find important vacuum information

Keep this information

Write the model, type and serial number here:

Date of purchase (keep your receipt) _____

Model number and type _____

Serial number _____

Find these numbers on a label on the middle back side of the vacuum cleaner. Refer to these numbers when ordering parts and accessories or if service is needed.



This Owner's Guide provides important instructions to prolong the life of your Eureka vacuum cleaner.

Registration: To register your product visit www.eureka.com and click on the 'Register Your Product' link in the top right corner.

Inspection: Carefully unpack and inspect your new Eureka vacuum cleaner for shipping damage. Each unit is tested and thoroughly inspected before shipping. For instructions regarding any shipping damage, call Eureka Customer Service **HELPLINE 1-800-282-2886** immediately.

Contents

Important safeguards	3
What comes in the carton	4
How to identify parts of your vacuum cleaner	5
How to assemble your vacuum cleaner	6
How to use your vacuum cleaner	7
How to maintain dust cup and filters	8
Problem Solving/Parts and Accesories	9
The Eureka limited warranty	10

 Follow caution information wherever you see this symbol.

IMPORTANT SAFEGUARDS

When using an electrical appliance, basic precautions should always be followed, including the following:

READ ALL INSTRUCTIONS BEFORE USING THIS VACUUM CLEANER

WARNING



To reduce the risk of fire, electric shock, or injury:

• Do not use outdoors or on wet surfaces.

• **Do not leave vacuum cleaner when plugged in.**

Turn off the switch and unplug the electrical cord when not in use and before servicing.

• Do not allow to be used as a toy. Close attention is necessary when used by or near children.

• Use only as described in this manual. Use only manufacturer's recommended attachments.

• Do not use with damaged cord or plug. If vacuum cleaner is not working as it should, has been dropped, damaged, left outdoors, or dropped into water, call the Eureka Customer Service **HELPLINE** at **1-800-282-2886**.

• Do not pull or carry by cord. Do not use cord as a handle. Do not close a door on cord or pull cord around sharp edges or corners. Do not run vacuum cleaner over cord. Keep cord away from heated surfaces.

• Do not use extension cords or outlets with inadequate current carrying capacity.

• Turn off all controls before unplugging.

• Do not unplug by pulling on cord. To unplug, grasp the plug, not the cord.

• Do not handle plug or vacuum cleaner with wet hands.

• Do not put any objects into openings. Do not use with any openings blocked; keep free of dust, lint, hair, and anything that may reduce airflow.

• This vacuum cleaner creates suction. Keep hair, loose clothing, fingers, and all parts of body away from openings and moving parts.

• Use extra care when cleaning stairs.

• Do not pick up anything that is burning or smoking such as cigarettes, matches, or hot ashes.

• Do not use without dust cup, filter, and pre-motor filter in place.

• Do not use to pick up flammable or combustible liquids such as gasoline, or use in areas where they may be present.

• Store your vacuum cleaner indoors in a cool, dry area.

• Keep your work area well lighted.

• Unplug electrical appliances before vacuuming them.

SAVE THESE INSTRUCTIONS

To reduce the risk of electric shock, this appliance has a polarized plug (one blade is wider than the other). This plug will fit in a polarized outlet only one way. If the plug does not fit fully into the outlet, reverse the plug. If it still does not fit, contact a qualified electrician to install the proper outlet. Do not change the plug in any way.



Motor

Do Not Oil the motor at any time. The bearings are permanently lubricated and sealed.

What comes in the carton

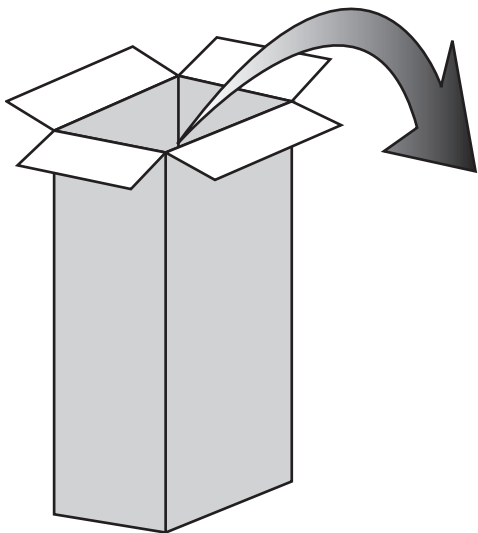

Important safeguards

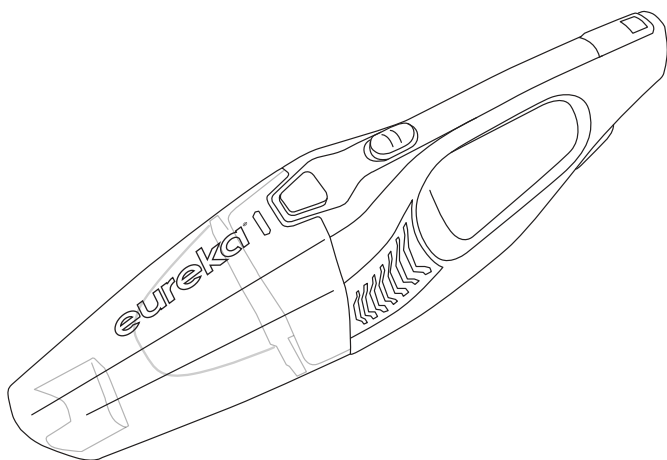

Hand vacuum

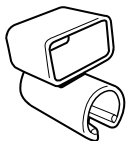

Crevice tool holder



Crevice tool

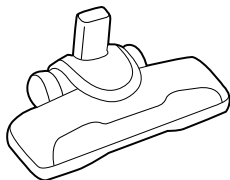

Removeable floor nozzle

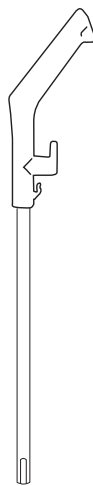

Handle

How to identify parts of your vacuum cleaner

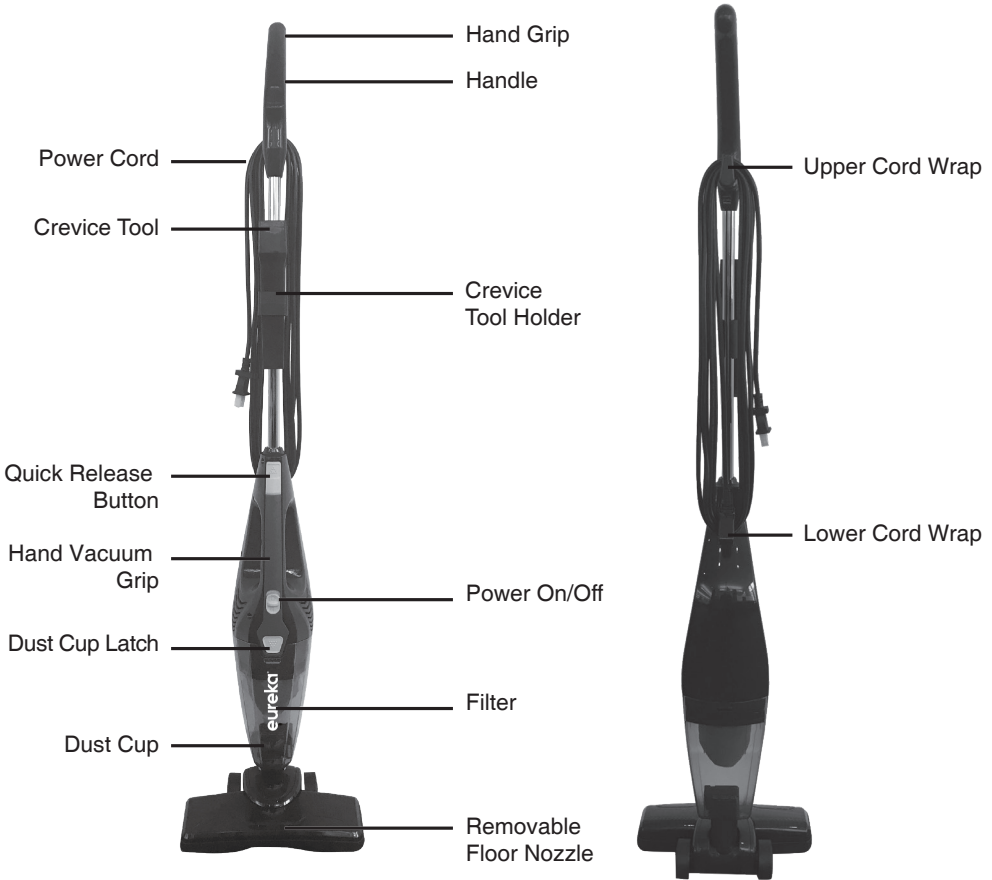

For filter maintenance instructions, see page 8

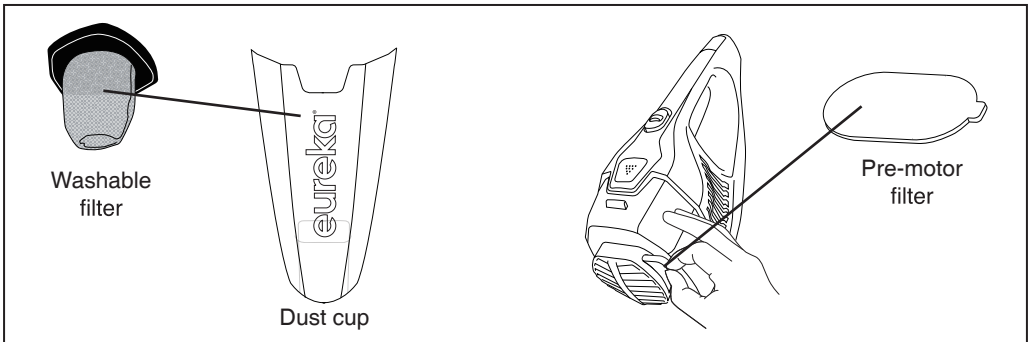

How to assemble your vacuum cleaner

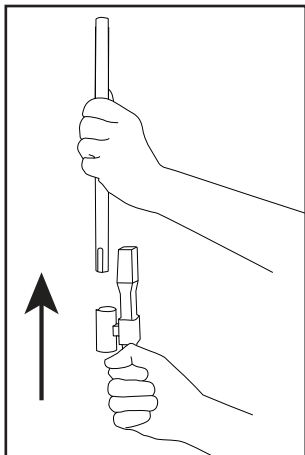

Attach crevice tool and holder by sliding it up onto the handle.

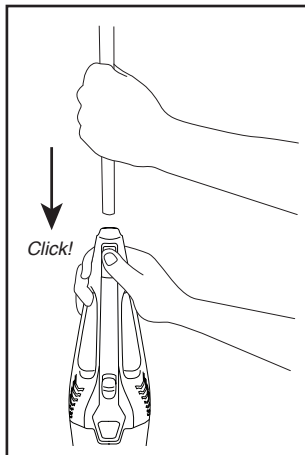

Press the quick release button on the hand vacuum grip and insert the handle. Make sure it is all the way inserted into the body of the vacuum.

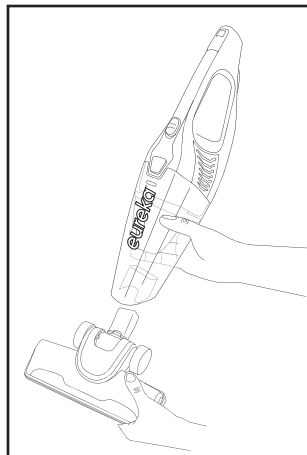

Attach the floor nozzle by inserting it into the opening at the bottom of the dust cup. Press firmly to secure in place.

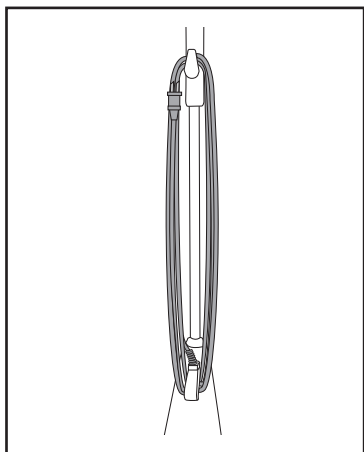

Wrap cord around the upper and lower cord wraps on the back of the vacuum. Clip plug onto the cord.

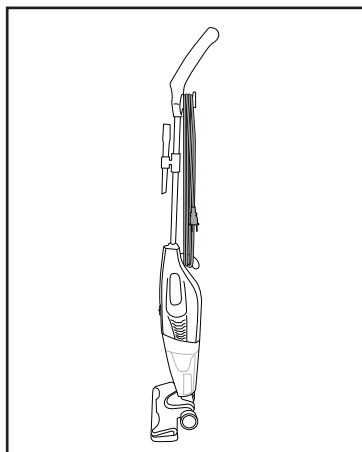

Tilt vacuum up into its upright position. Click!

How to use your vacuum cleaner

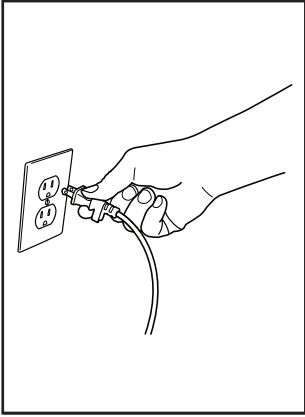

Plug power cord into the outlet.

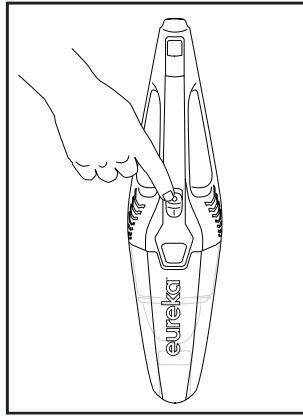

Turn on power switch on the front of the hand vacuum.

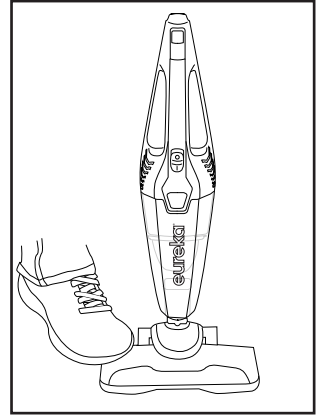

Step on nozzle and tilt vacuum to release from its upright position.

Additional usage methods

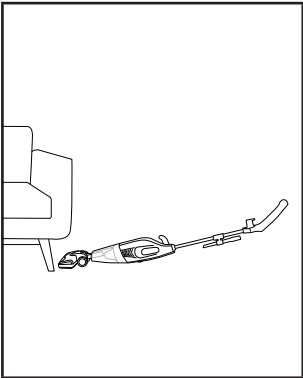

Turn hand vacuum 180° as shown for better reach under furniture.

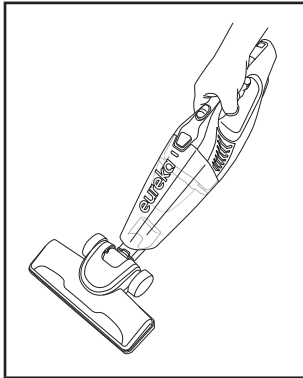

Floor nozzle may be used with the hand vacuum to clean wider surfaces.
To attach floor nozzle to the hand vacuum, insert it into the opening at the bottom of the hand vacuum. Press firmly to secure in place.

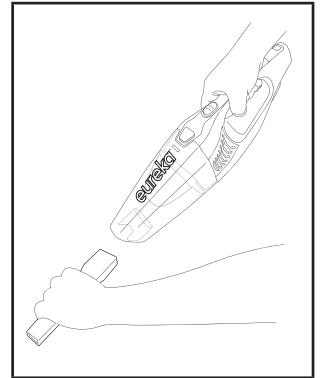

Insert crevice tool to extend the length and reach of the hand vacuum.

How to maintain dust cup and filters

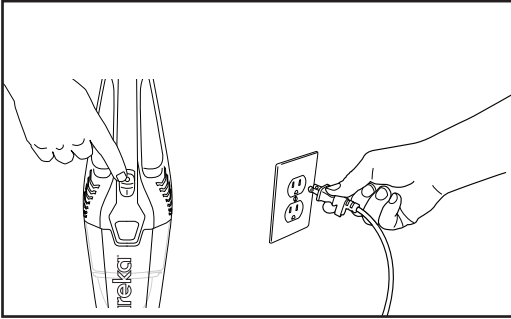

Turn vacuum off. Then, unplug the vacuum.

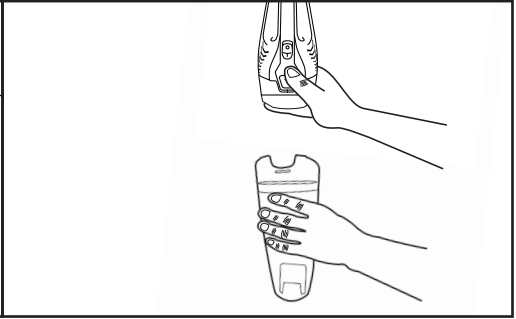

To remove dirt from the dust cup and filter, hold vacuum vertically. Press dust cup latch to release the dust cup as shown.

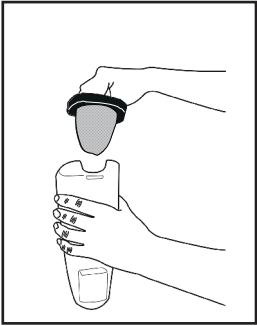

Gently remove the filter as shown.

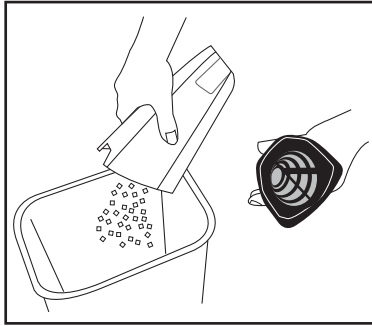

Empty dust cup into waste container.

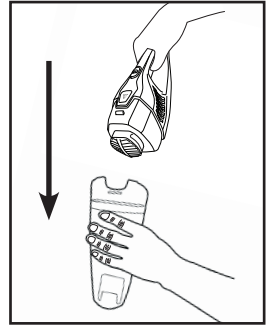

Replace filter. Attach dust cup to vacuum. Make sure dust cup is correctly secured.

Maintaining pre-motor filter

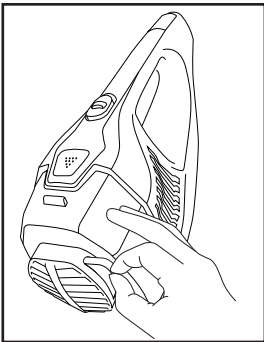

To optimize suction and cleaning performance, remove and inspect the pre-motor filter regularly.

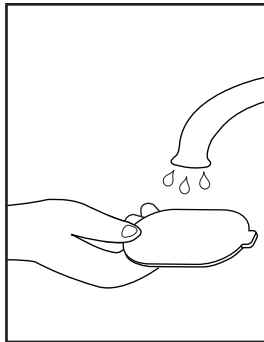

If needed, clean with warm water and a mild detergent.

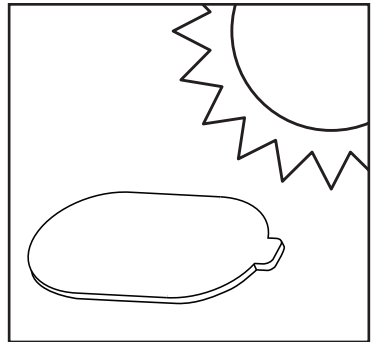





Air dry pre-motor filter for 24 hours before placing back in the vacuum.

Problem Solving

⚠ Make sure vacuum is turned off and power cord is unplugged.

Problem	Solution
Motor will not start.	1. Push plug securely into outlet, try another outlet, or check circuit breaker.
Vacuum cleaner does not vacuum effectively.	1. Filters may be clogged, wet, or dirty. Follow instructions for cleaning filters. 2. Dust cup may be full. Follow instructions for emptying dust cup.
Dust blows out of air vents.	1. Ensure filters are properly secured.

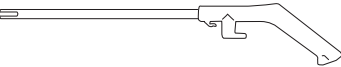
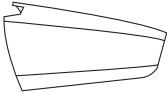
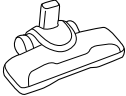
Parts and Accesories

	Filter	N0101
	Pre-motor filter	N0102
	Crevice tool	N0103
	Handle	N0104
	Dust cup	N0105
	Nozzle	N0106
	Crevice tool holder	N0107

The Eureka one-year limited warranty

Midea America Corp. ("Eureka"), subject to the terms and conditions herein, warrants this vacuum cleaner to be free from defects in material and workmanship for a term of one year from the date of original purchase when used in accordance with the Eureka operating and maintenance instructions and under normal household usage. This warranty is granted only to the original purchaser and members of immediate household, and is applicable only to original purchases from Eureka authorized resellers.

What Eureka will do:

Eureka will, at its option, repair or replace a defective vacuum or vacuum part that is covered by this warranty. Repairs may be performed using new or refurbished parts that meet or exceed Eureka specifications for new parts. If Eureka elects to replace the vacuum, the replacement may be a reconditioned unit. Depending on availability of products, Eureka reserves the right to provide you with a replacement product that is the same or similar, or substitute equivalent of the original product. As a matter of warranty policy, Eureka will not refund the consumer's purchase price.

This warranty does not cover:

- Normal wear and tear of the vacuum and vacuum parts that require replacement under normal use such as disposable dust bags, filters, drive belts, light bulbs, brush-roll, bristles, impellers and cleaning.
- Damages or malfunctions resulting from: improper or unreasonable use or maintenance, abuse, negligence, failure to follow instructions contained in any written materials that accompany the product, deterioration by reason of excess moisture, corrosive atmosphere, lightning, power surges, connections to improper voltage supply, unauthorized alteration, or other external causes such as extremes in temperature or humidity, modifications, scratches or discoloration, accidents, misuse, or acts of God. This warranty also does not cover damage resulting from repair or attempted repair by anyone other than Eureka or an authorized Eureka Warranty Station. This warranty is not applicable to any product that has been altered or on which the serial number has been defaced, modified or removed. Altering, erasing, or forging any proof-of-purchase documents voids any applicable product warranty.

Obtaining warranty service:

To obtain warranty service you must contact the Eureka Service Team, toll free, at 1-800-282-2886 or email customerserviceusa@midea.com, to discuss the warranty claim and procedures to be followed. All warranty claims must include submission of proof-of-purchase documentation. For additional information, you may also visit www.eureka.com.

Shipping charges:

You will be responsible for any initial shipping and insurance charges if the defective product(s) must be shipped for warranty service or warranty evaluation; however, Eureka or a Eureka Authorized Warranty Station will pay the return shipping charges if repairs are covered by the warranty. When returning parts for repair, you must include the model, type and serial number located on the rating plate on the lower backside of the vacuum. If any product submitted for warranty service is found to be ineligible, an estimate of repair cost will be furnished and the repair performed only if requested by the owner and upon receipt of payment or acceptable arrangements for payment.

Further limitations and exclusions:

Any warranty that may be implied in connection with your purchase or use of the vacuum, including any warranty of Merchantability or any warranty of Fitness For A Particular Purpose is limited to the duration of this limited warranty. Some states do not allow limitations on how long an implied warranty lasts, so the above limitations may not apply to you.

Your relief for the breach of this warranty is limited to the relief expressly provided above. In no event shall the manufacturer be liable for any consequential or incidental damages you may incur in connection with your purchase or use of the vacuum. Some states do not allow the exclusion or limitation of incidental or consequential damages, so the above limitation or exclusion may not apply to you.

This warranty gives you specific legal rights. You may also have other rights, which may vary by state.

Midea America Corp.
200 Rivers Edge Drive
Medford, MA. 02155
USA

Owner's Guide

Do not return to the store, call
Eureka Customer Service
HELPLINE 1-800-282-2886

www.eureka.com



Eureka stands by
our Clean Promise seal.
Learn more at
www.eureka.com/cleanpromise



© 2018 Midea America Corp. Printed in China 02155210_rev2

eureka®