

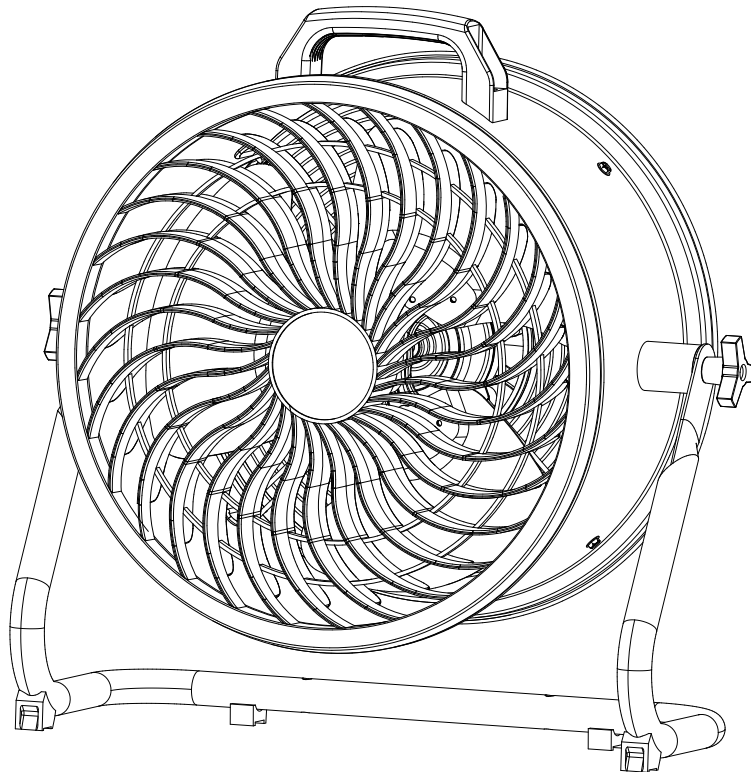

16" Turbo Fan



MODEL: ILG8TF16-DC
120V 60Hz

Owner's Manual

**PLEASE READ AND
SAVE THESE INSTRUCTIONS**

TABLE OF CONTENTS

Important Instructions.....	3-5
Specifications	6
Operating Instructions.....	7
Maintenance and Cleaning.....	8
Troubleshooting.....	9-10

SAFETY INFORMATION

When using electrical appliances, basic safety precautions should always be followed to reduce the risk of fire, electrical shock, and injury to persons including the following:

WARNING: 1. Please read and understand this entire manual before attempting to assemble, install or operate the product. Do not use the fan unless you have read these instructions.

Intended Use

2. Use this appliance only as described in the manual. Any other use not recommended by the manufacturer may cause fire, electric shock or injury to persons. The manufacturer assumes no responsibility for damage or injury due to unauthorized use or product modification. Failure to follow these instructions will void the product warranty.

3. This fan is designed for indoor household use only.

WARNING: Risk to Children and Impaired Persons

4. This fan is not intended for use by people (including children) with reduced physical, sensory or mental capabilities or lack of experience and knowledge unless they have been given supervision or instruction concerning use of the fan by a person responsible for their safety.

5. Close supervision is necessary when any appliance is used by or near children.

6. Keep the fan out of reach of young children.

Safety of Operation Environment

7. DO NOT use this fan outdoors or expose it to weather or elements.

8. DO NOT use the fan close to the fires, cooking or other heating appliance. Do not operate in the presence of explosive and/ or flammable fumes.

9. DO NOT use the fan to exhaust hazardous or explosive materials and vapors.

10. DO NOT run cord under carpeting. Do not cover cord with throw rugs, runners, or similar coverings. Do not route cord under furniture or appliances. Arrange cord away from traffic area and where it will not be tripped over.

11. Make sure that the fan do not get wet (water splashes etc.). Do not immerse the fan, plug and/or the power cord in water or other liquids or use near sinks, baths, or showers.

12. To reduce risk of electrical shock and injury to persons, do not use in window.

13. Place this fan away from curtains, draperies, tablecloths and other fabrics, since they may be drawn into the fan, damage the motor and/or cause a fire.

14. Keep work area clean and well lit.

15. Keep loose or flying hair away from the fan.

16. Always use on a dry, level, stable surface to avoid overturning.

Operation Safety

17. Do not operate the fan until fully assembled with all parts properly in place.

18. Do not leave the fan unattended when in use.

19. Always switch off and unplug the fan when not in use, before moving fan from one location to another, before putting on or taking off parts and before cleaning or performing maintenance. To disconnect, grip plug and pull from outlet.

20. DO NOT insert your hand or other objects into the guard or the movable parts.

SAFETY INFORMATION

21. Do not disassemble or modify the fan.
22. All servicing, apart from ordinary cleaning, should be performed by qualified personnel only. Those who are not certified electricians should not disassemble, repair or rebuild the fan. There are no user-serviceable parts inside.
23. Do not subject the fan to violent impacts.
24. Do not incinerate this fan even if it is severely damaged.
25. Do not touch the fan with wet hands.
26. Do not operate any appliance with a damaged cord or plug or after the appliance malfunctions, or if it has been dropped or damaged in any manner. Discard fan or return to an authorized service facility for examination and/or repair.
27. DO NOT use the fan when there is damage to the cable cord or plug. If the supply cord is damaged, it has to be replaced by the manufacturer, its service agent or similarly qualified persons.
28. To reduce the risk of fire or electric shock, do not use this fan with any solid-state speed control device.
29. Do not use this fan as a dryer. Make sure nothing is blocking the airflow outlet and air intake grille.
30. Always plug the fan directly into a wall outlet/receptacle. Never use with an extension cord or relocatable power tap (outlet/power strip).
31. Do not abuse the power cord. Do not use the cord for carrying, pulling or unplugging fan.
32. Do not let the cord hang over the edge of a table, counter, sharp edges, moving parts or come in contact with oil or hot surfaces, including the stove.
33. This product employs overload protection (fuse). A blown fuse indicates an overload or short-circuit situation. If the fuse blows, unplug the product from the outlet. Replace the fuse as per the user servicing instructions (follow product marking for proper fuse rating) and check the product. If the replacement fuse blows, a short-circuit may be present and the product should be discarded or returned to an authorized service facility for examination and/or repair.

Disposal

34. We encourage you to participate in recycling program, so please observe local regulations for proper disposal of discarded products.
35. Recycle raw materials instead of disposing of as waste. The machine, accessories and packaging should be sorted for environmental-friendly recycling.

SAFETY INFORMATION

36. **WARNING:** To Reduce The Risk Of Fire, Electric Shock Or Injury To Persons, Do Not Use Replacement Parts That Have Not Been Recommended By The Manufacturer (e.g. Parts Made At Home Using A 3D Printer).

37. Children should be supervised to ensure that they do not play with the appliance.

SAVE THESE INSTRUCTIONS.

Refer to them frequently and use them to instruct others who may use this fan. If you are to loan someone this fan, loan them these instructions also.

SPECIFICATION

MODEL NO.: ILG8TF16-DC

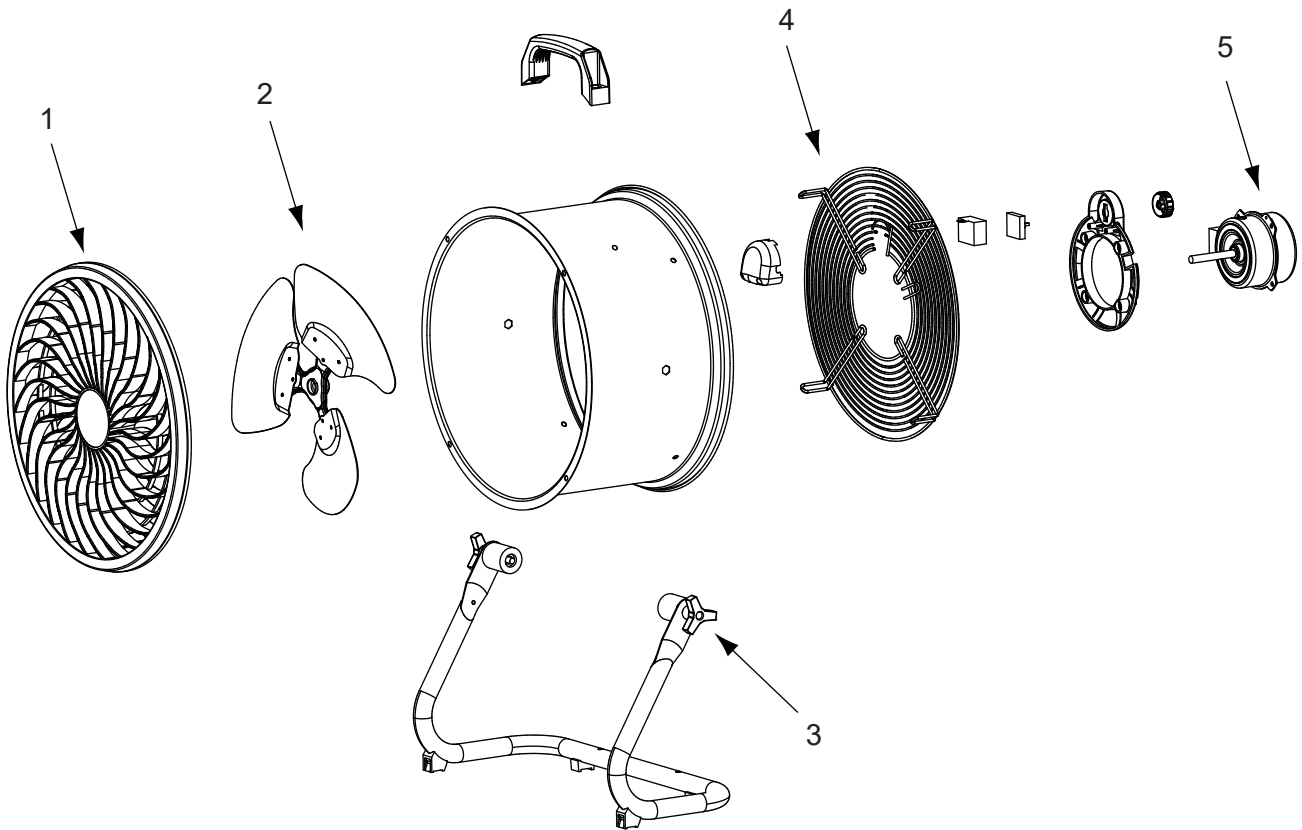

Parts of the fan

PART	DESCRIPTION	QUANTITY	PART #
1	Front grill	1	SP-40DC-01
2	Blade	1	SP-40DC-02
3	Star knob	2	SP-40DC-03
4	Rear grill	1	SP-40DC-04
5	Motor	1	SP-40DC-05

Product Specifications

Voltage	120V, 60Hz
Current	1.35A
Power	162 Watts
RPM	1510
Speeds	3
CFM	2687
Noise Level	66 dB

OPERATION INSTRUCTION

1. Position a rubber pad (D) between the fan head (A) and one side of the stand (B), aligning the rubber pad (D) with the predrilled holes.
2. Secure the stand (B) to the fan head (A) by inserting an adjustment knob (C) through the stand (B), rubber pad (D), and into the fan head (A). Repeat for the other side of the fan.

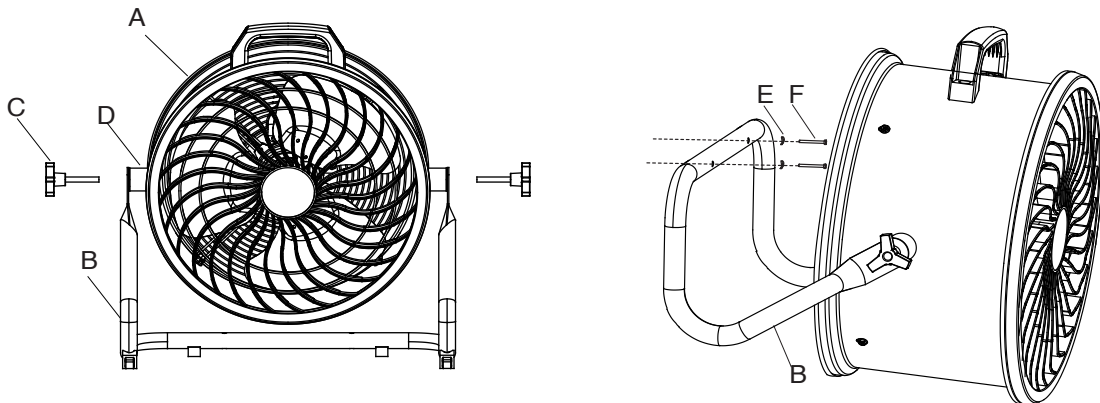

Wall-Mount Instruction

WARNING: Ensure the front and rear guard screws are completely screwed down in the locking position before operation.

WARNING: Mount fan on a wooden wall only.

WARNING: To reduce the risk of electric shock and personal injury, ensure the location for all mounting is able to support this fan.

WARNING: This fan is recommended to be mounted by a qualified electrician.

1. Mark the locations of mounting holes and drill pilot holes.
2. Align holes on stand of the fan to pilot holes and mount the fan to wall by tightening the washers (E) and screws (F) provided.

MAINTENANCE AND CLEANING

WARNING: Parts replacement and troubleshooting to be performed only by qualified personnel.

WARNING: Do not depend on any switch as the sole means of disconnecting power when installing or servicing the fan. Failure to do so may result in fatal electrical shock.

WARNING: Unplug the fan from the wall outlet before servicing or cleaning.

CAUTION: There is no user maintenance part except regular cleaning as following description. All other servicing or maintenance should be performed by qualified service personnel.

To clean the fan, use a soft damp cloth. Wipe down with a dry cloth. Do not use cleaners that are harmful to paints or plastics.

CAUTION: Do not use gasoline, benzene, thinner, harsh cleaners, etc., which are dangerous and will damage the air circulator.

The propeller, guard, and motor should be cleaned periodically to prevent overheating, and/or operating in an imbalanced condition.

CAUTION: If cleaning requires the removal of a guard, remove only the front guard and re-install when finished in its originally installed position. Do not repair propeller if it becomes damaged. The propeller is accurately balanced at the factory and should be replaced if damaged.

Do not bend the propeller. The propeller is accurately balanced at the factory and should be replaced if damaged.

Do not repair propeller if it becomes damaged.

IMPORTANT: Ensure that propeller is replaced in correct direction as factory installed.

Motor is permanently lubricated.

TROUBLE SHOOTING

If your fan fails to operate, please follow these Instructions:

1. Make sure the fan is plugged in and the electrical outlet is working properly.
2. Check for any obstruction. If you find an obstruction, turn the fan "OFF". Unplug the fan and carefully remove the obstruction.

Plug the fan in and turn it on again. It should resume normal operation.

NOTE: IF YOU EXPERIENCE A PROBLEM WITH YOUR FAN, PLEASE DO NOT ATTEMPT TO OPEN OR REPAIR THE FAN YOURSELF. DOING SO COULD CAUSE DAMAGE TO THE FAN AND/OR PERSONAL INJURY. Always consult the manufacturer before further use.

Warranty Information

This product comes with a 1-YEAR LIMITED COMPONENT WARRANTY. If your unit does not appear to be working properly, please contact our service center by calling 1-800-317-1688. Prior to your call, we encourage you to visit our service related website www.ilivingusa.com for troubleshooting tips and service instructions if needed.

Register your product at our website:

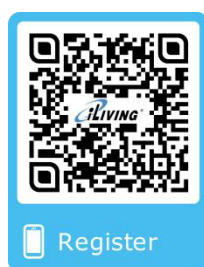

Or visit iLivingUSA.com/register-product

Feedback

Love it? Help us make the product more for you.



Let us know with a customer review.

Please visit: <https://www.amazon.com/review/review-your-purchases#>

At iLiving USA, we are committed to bringing top quality products to our customers.

iLIVING USA
860 Mahler Road,
Burlingame, CA 94010
Tel: 1-800-317-1688
Email: service@ilivingusa.com