



waykar

USER MANUAL

Commercial Dehumidifier

CPL250A >

Please read the manual carefully before operating the device and keep it for future reference.

Message from WAYKAR

Thank you for choosing Waykar. Established in 2014 with a commitment to protecting indoor climates, Waykar has grown into a leading brand in the HVAC industry, known for premium products that prioritize comfort and health in your indoor space.

Before you start exploring this product, read this manual carefully for necessary instructions first. It's advised to keep it for future reference.

24/7 Full-Time Response

Upon receipt of the dehumidifier, kindly inspect the package contents immediately for any potential missing or damaged parts. In case of issues, we would appreciate your prompt contact with Waykar support for solutions before initiating a return. Send us an email or scan the QR code to start a live chat.

support@waykar.com



Important: Please Read Before Usage

Ensure the dehumidifier is always kept in an upright position to avoid internal damage. After unwrapping the dehumidifier, please set it upright and let it sit for **24 HOURS** before plugging it in.

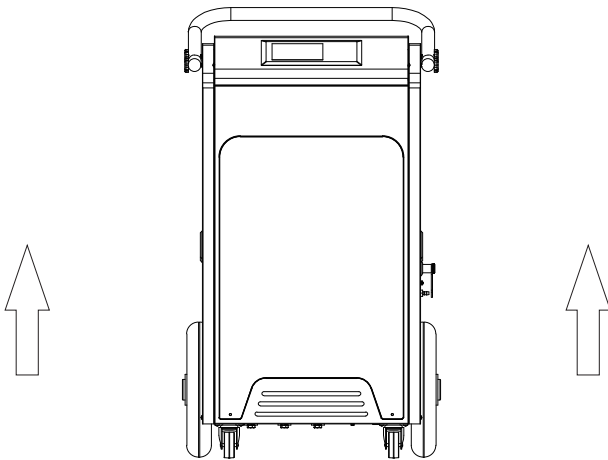

Note: The graphic illustrations in this manual are for demonstration purposes only. The actual product may vary slightly in size and shape.

Table of Contents

GENERAL SAFETY PRECAUTIONS.....	01
PARTS ILLUSTRATION.....	03
PACKAGE CONTENTS.....	04
INSTALLATION GUIDE.....	04
FUNCTION OVERVIEW.....	06
OPERATION INSTRUCTIONS.....	09
TROUBLESHOOTING.....	12
SPECIFICATIONS.....	13
MAINTENANCE & CLEANING.....	14
WARRANTY & CONTACT.....	24

GENERAL SAFETY PRECAUTIONS

- The dehumidifier is designed for indoor use only and is not intended for operation on public transport, such as buses, subways, and trains.
- Avoid placing the device on soft, shaky, or uneven ground, as this may cause vibration and movement during operation.
- Verify that the dehumidifier's voltage matches your electrical supply and plug it into grounded outlets in accordance with local regulations regarding electrical safety.
- Ensure that the drain hose runs downward without bending or winding to facilitate continuous water drainage.
- Avoid contact with water as the dehumidifier is not waterproof.

-
- Be sure to unplug the dehumidifier first before cleaning or packing it.
 - Turn off the dehumidifier before unplugging the device.
 - For damaged cords, please contact the manufacturer or certified technicians for replacement to avoid hazards.
 - Do not dismantle or modify the device without professional certification. Such actions may lead to safety hazards and void the warranty.
 - If the dehumidifier is not going to be used for an extended period, please remember to unplug it.

-
- Keep the dehumidifier away from direct sunlight, heat-generating devices, and flammable materials, including stoves, gasoline, etc.
 - Avoid sitting, standing, or placing heavy objects on the device.
 - No pesticides or flammable liquids are allowed near the device.
 - Avoid inserting fingers, rods, or other thin objects into the air inlet and outlet grilles of the dehumidifier.
 - Stop and unplug the device immediately at any sign of malfunction.

GENERAL SAFETY PRECAUTIONS

- Do not tilt the device to prevent spilled water from damaging it.
- Children aged 8 and above, as well as individuals with reduced physical, sensory, or mental capabilities, should operate the device only under supervision. Children under 8 should not tamper with it.
- Use soft cloth for cleaning and avoid splashing water directly on it.
- Neutral detergents are recommended for surface cleaning. Alcohol, gas, and benzene are prohibited for cleaning purposes.

WARNING

Do not use means to accelerate the defrosting process or to clean the appliance, other than those recommended by the manufacturer. Risk of Fire or Explosion—Store in a well-ventilated room without continuously operating flames or other potential ignition. Do not pierce or burn. Be aware that refrigerants may not contain an odor.



A2L

- The transportation and disposal of this dehumidifier must comply with local regulations regarding flammable refrigerants.
- The appliance shall be installed, operated and stored in a room with a floor area larger than 54 sq. ft.
- Under no circumstances should you pierce or burn the dehumidifier casing, which may lead to refrigerant leak. Be aware that refrigerants may be odorless.
- Device maintenance and repair should be left to trained professionals due to the potential safety hazards and environmental concerns associated with refrigerant leaks. Certified technicians can consult the [Maintenance & Cleaning](#) section in this manual for guidance on handling the flammable refrigerant with caution.

PARTS ILLUSTRATION

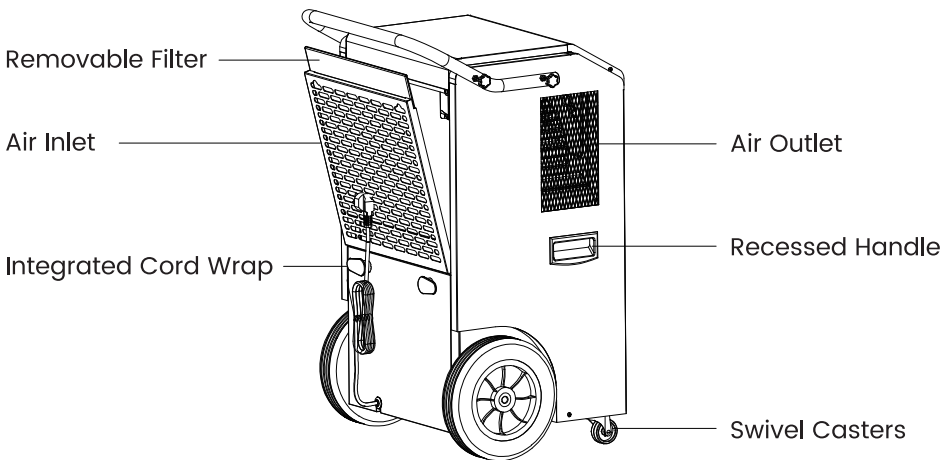
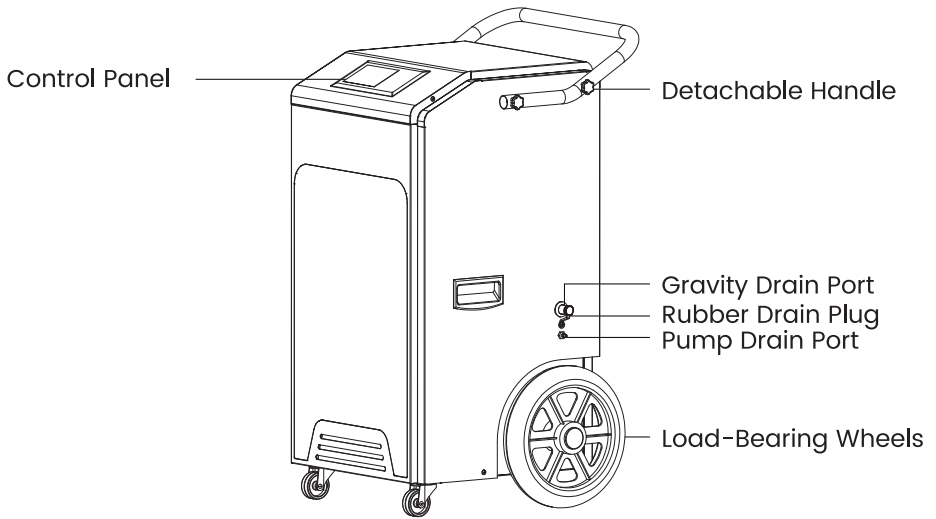

PACKAGE CONTENTS

The package of the CPL250A dehumidifier contains the following items:

- 1 × Commercial Dehumidifier with Cart Handle
- 1 × Drain Hose (6.6 ft)
- 1 × Pump Drain Hose (16.4 ft)
- 1 × Drain Hose Clip

INSTALLATION GUIDE

Device Positioning & Placement

1. The operational temperature range for the dehumidifier must be maintained between 41°F to 100°F (5–38°C). Operation outside of this specified temperature range may lead to potential damage to the product. Therefore, please do not place the device in an area where temperatures fall outside of this range.

2. When positioning the dehumidifier, please ensure it is not placed too close to walls or other objects, as this could obstruct the air vents. Maintain a minimum clearance of 39 inches above and around the device, as depicted in the diagram.

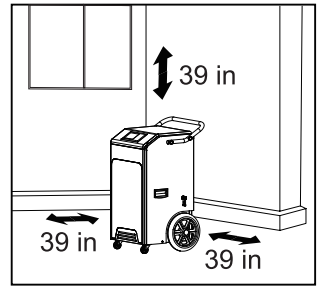

3. The device should be positioned, operated, and stored in an area with a minimum space of 54 sq. ft.

Water Drainage

This dehumidifier provides two efficient drainage options: gravity drain and pump drain. Both methods effectively remove condensate water from the internal reservoir, ensuring continuous operation and hassle-free maintenance.

1. Pump Drain Hose Connection

The built-in pump automatically drains water upward or over an extended distance when the internal reservoir reaches the maximum water level. Please ensure the pump drain hose is properly attached before turning on the dehumidifier.

INSTALLATION GUIDE

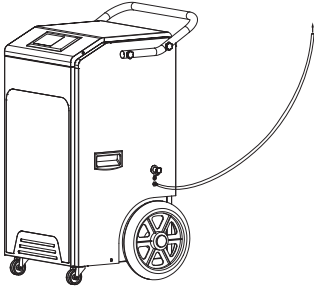

Note:

1. Supports up to a maximum of 16.4 ft water lift. Water leakage might occur if the drain height exceeds 15 ft vertically.
2. If the dehumidifier operates without any hose attached, the pump may start draining water onto the floor once its internal reservoir is full. Under such circumstances, please unplug the device directly to stop the pump, as turning off the device might not stop it.

2. Gravity Drain Hose Connection

If the pump drain malfunctions or vertical lift isn't needed for water drainage, you can connect the provided drain hose to the Gravity Drain Port to directly drain water out of the internal reservoir.

Note:

1. Besides the provided drain hose, you can also connect a standard garden hose (NOT included) to the Gravity Drain Port.
2. If no hose is connected for gravity drain, please make sure to tighten the drain plug of the Gravity Drain Port to prevent water leakage.
3. The hose should run smoothly downward without bending or winding to prevent water leakage.
4. It's not recommended to extend the drain hose by connecting two hoses together, as this might lead to water leakage.

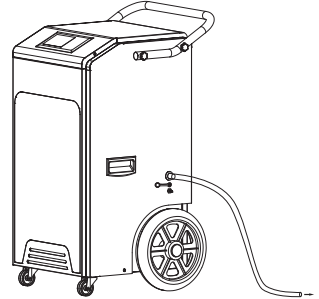

Note:

The drain hose should run smoothly downward and remain at least 3.94 inches lower than the drain port level to prevent water leakage.

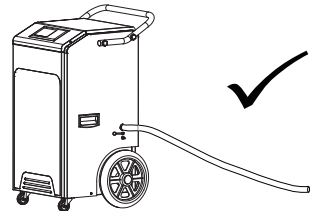
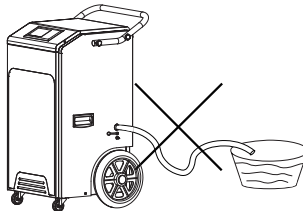
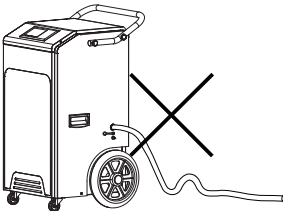

FUNCTION OVERVIEW



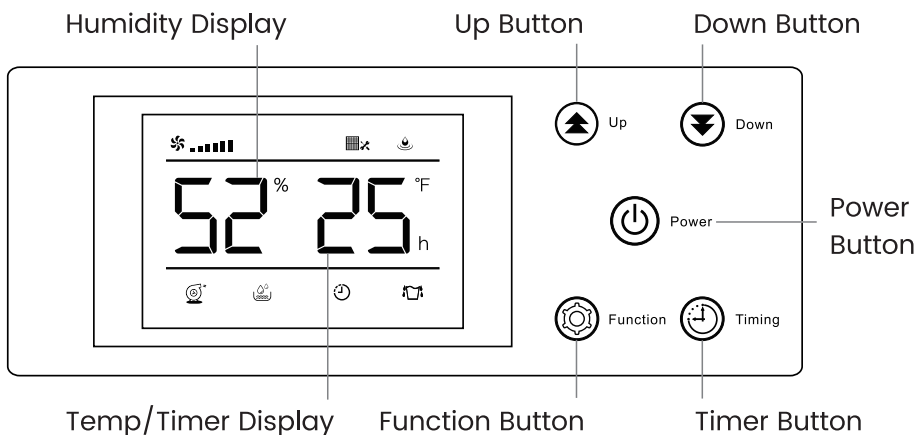





Control Panel Illustration



Note: Hold down the Power Button for 5 seconds to manually start the pump drain.

Indicator Explanation

The table below illustrates the meanings of each indicator in different statuses.

	Compressor Indicator On: The compressor is running. Off: The compressor has stopped. Flicker: Delayed compressor running.		Full Water Indicator Flicker in Red: Full internal reservoir.
	Humidity under Control Symbol Flicker: The space humidity has reached the target humidity level.		Pump Indicator On: Water pumping in progress. Off: Pumping not activated.
	Timer Indicator On: A timer has been set. Off: No timer set at the moment. Flicker: Timer setting in progress.		Fan Indicator On: The fan is running. Off: The fan has stopped.
	Filter Cleaning Reminder Flicker: The filter requires cleaning after 30 days of accumulated operation.		High Temperature Protection The compressor will stop when the space temperature rises above 45°C/113°F, the max allowable temperature.
	Low Temperature Protection The dehumidifier will completely shut down when the space temperature falls below 4°C/39°F, the minimum allowable temperature.		

FUNCTION OVERVIEW

Features

24-Hour Timer

Utilize the timer feature to automatically schedule your dehumidifier to turn on or off within a maximum duration of 24 hours. When the device is running, set a timer to cease operation at your desired hour. In standby mode, use the timer to automatically start dehumidification within your specified time frame.

Smart Humidity Control

This dehumidifier features a built-in humidity sensor for smart humidity control. It automatically detects and displays real-time humidity levels on the screen for easy monitoring.

When the humidity drops more than 3% RH below your preset level, the dehumidifier pauses operation, with the "🌫️" symbol flickering. Both the compressor and fan stop, but you can still adjust settings.

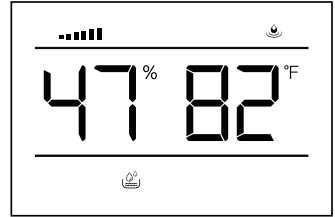

The unit resumes operation when humidity rises above the target level, ensuring efficient and convenient humidity control.

Note: The displayed humidity level may deviate by 3–5% RH from the actual humidity level.

Power-off Memory Restart

In the event of an unexpected power failure or accidental unplugging, the dehumidifier offers automatic restart, seamlessly resuming operation with your previously saved settings once power is restored.

Please note that any set timer will be interrupted and require resetting.

Auto Defrosting

Designed for optimal performance, it effortlessly tackles frost build-up on its coils, ensuring energy efficiency even in low temperatures.

During defrosting, the compressor stops, the fan switches to high speed, and the display flashes the "🌫️" symbol.

FUNCTION OVERVIEW

3-Minute Delay Compressor Protection

In case of frequent power cycling, the 3-minute compressor protection will be triggered to enforce a 3-minute delay before restarting the compressor. The compressor indicator flickers to indicate the delayed compressor start.

During this delay, only the fan will operate, noticeable by the cool air from the air outlet. Once the compressor kicks in, warm air will be expelled from the air outlet.

Filter Cleaning Reminder

After 30 days of cumulative operation, it will prompt a filter cleaning alert with the "■x" icon, which will persist even after a power cycle.

After cleaning the filter, you can reconnect the dehumidifier and put it into standby mode. Then press and hold the  button for 3–5 seconds until the display flickers once, indicating that the filter cleaning alert has been released, and the 30-day counter will be reset.

Continuous Dehumidifying

If the target humidity level is set to 10% RH, the dehumidifier will automatically enter continuous operation mode. This setting is ideal for extremely humid environments, such as basements.

Auto Pump & Full Water Protection

This commercial dehumidifier includes an internal reservoir to collect condensate and a built-in pump for efficient drainage. You can start the pump drain in two ways:

- **Auto Start at Full Water:** When the reservoir reaches full capacity, the pump automatically activates to drain water.
- **Manual Start:** Press and hold the Power Button for 5 seconds to manually activate the pump.

Additionally, you can drain the internal reservoir via the Gravity Drain Port. Attach the included 6.6 ft hose for drainage if long-distance or upward drainage isn't needed.

FUNCTION OVERVIEW

If the Gravity Drain Port is sealed with a plug and the pump isn't draining water, condensate will accumulate in the reservoir until it reaches capacity, triggering Full Water Protection. When this occurs, the compressor will stop operating immediately, and the fan will shut down after a 3-minute delay. The Full Water Indicator will blink when the dehumidifier is plugged in, reminding you to attach hoses for draining the reservoir.





Note: If the Full Water Indicator stays illuminated on the display, it indicates that the pump is not functioning properly.

OPERATION INSTRUCTIONS

1. Power On/Off & Standby Mode

Upon being plugged in, the dehumidifier's display will briefly illuminate to indicate it is connected to power. It will then enter standby mode with the screen off.

Press the  button to turn on the dehumidifier. The display will show real-time readings of the room temperature (°F) and humidity level (%). Note: Due to the compressor protection mechanism, there will be a short start delay for the compressor, indicated by the flickering of the  symbol.

Note:

- You can also hold down the Power Button for 5 seconds to manually start the pump drain.

2. Humidity Setting

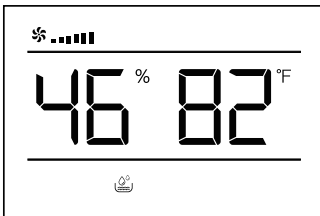

Once activated, the dehumidifier will automatically detect and display the space humidity on the screen (with the "%" symbol). The reading will be continuously updated in real-time to help you monitor the space humidity.

OPERATION INSTRUCTIONS

Press [▲] or [▼] to set your target humidity, ranging from 10% RH to 98% RH in 1% RH increments. You can also press and hold the buttons for continuous adjustment.

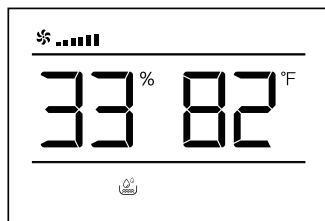
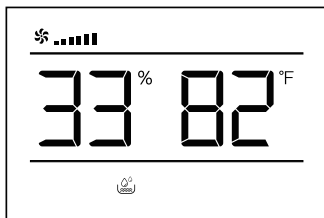

After completing the settings, press the [⊙] button to confirm, or wait 5 seconds for the system to exit automatically.

3.Timer Setting

Use the timer setting to schedule the dehumidifier to automatically turn on or off. Please note: The 24-hour timer is for one-time operation only and cannot be set to repeat. To cancel a timer, you will need to manually set the timer length to zero. Additionally, be aware that any timer settings will be cleared if the power is interrupted or if the unit is turned off and on again.

Programmed Shut-down:

1. Press [⊙] to access the timer settings. The "Timer" indicator and the timer duration will begin to flicker on the screen.

2. Press the Up or Down button to set the timer duration, cycling through 0 to 24 hours.

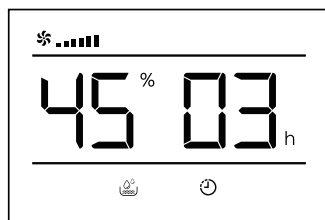

3. After selecting the timer duration, press the [⊙] button to confirm, or wait 5 seconds for the system to exit automatically.

4. Once the timer is successfully set, the timer indicator will illuminate, displaying the remaining hours.

OPERATION INSTRUCTIONS

Programmed Start-up:

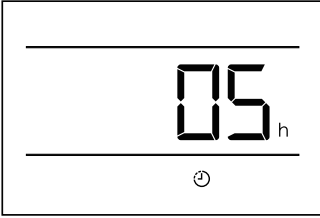

1. In standby mode, the timer button is still functional for setting the auto-on timer for the dehumidifier.
2. Press the [⌚] button and select a duration using the [▲] or [▼] button. Once a timer is successfully set, the Timer indicator will

illuminate, displaying the remaining hours as well.

3. The auto-on timer will restore the previous humidity setting from before the last power-off.

Error Code Explanation

Error	Meaning	Solutions
EC	Control Panel Communication Error	Check the connection between the control panel and main board. If the issue persists, contact customer service for assistance.
E1	Humidity Sensor Error	Check the humidity sensor for any disconnection or damage. Contact customer service for assistance.
E2	Defrost Sensor #1 Error	Check Defrost Sensor #1 for damage or loose connections. Contact customer service for assistance.
E4	Temperature Sensor Error	Inspect the temperature sensor for any disconnection or damage. Contact customer service for assistance.

For E1, E2, and E4 errors, a 15-second alarm will sound, and the corresponding error code will be displayed on the screen. Press any button on the control panel to silence the alarm.

TROUBLESHOOTING

If your dehumidifier malfunctions, we recommend trying the following troubleshooting steps before contacting the manufacturer. This can help you save time and potentially resolve the issue.

The listed problems are common issues that may occur with general dehumidifiers. It's important to note that this doesn't imply that this dehumidifier is prone to defects over time.

If the problem persists after following the recommended actions, please unplug the dehumidifier and contact Waykar Customer Service as soon as possible for assistance.

Problems	Possible Causes	Solutions
Unable to run the dehumidifier	Loose power connection	Check if the device is properly plugged into a working electrical outlet.
	Damaged power connector	Contact the manufacturer for solutions.
	Space temperature out of the recommended range	The device can only operate in temperatures between 41°F and 100°F.
Not effectively dehumidifying the space	Dusty filter	Clean the filter.
	Blocked air inlet or outlet	Ensure that the inlet or outlet is kept clear of any objects.
	Open doors and windows	Keep windows and doors closed for efficient moisture removal.
	Refrigerant leaked	Open the window and contact the manufacturer for solutions.
Much noise	Unstable device placement	Position the dehumidifier on a flat surface.
	Blocked filter	Clean the filter.
	Tittering sound?	Refrigerant flowing sound. No action required.
Water leakage	Loose hose connection	Ensure that the hoses are firmly attached.
	Tilted device	Place the dehumidifier on even ground.
	Blocked drain port	Clean the port and ensure the drain hose is clear and smooth.
Humidity display error (constantly at 25% or 99% RH)	Humidity sensor failure	Contact professional maintenance staff to repair and replace the humidity sensor.

SPECIFICATIONS

Model	CPL250A
Power Source	120V/60Hz
Rated Power	1300 W
Rated Current	11 A
Moisture Removal (65°F, 60%RH)	60 Pints/Day
Moisture Removal (80°F, 60%RH)	110 Pints/Day
Moisture Removal (86°F, 80%RH)	190 Pints/Day
Moisture Removal (95°F, 90%RH)	250 Pints/Day
Motor FLA	1.3 A
Motor Compressor	RLA: 9.7 A LRA: 43 A
Refrigerant/Charge	R32/15.2ozs (430 g)
Maximum Allowable Pressure	6.5 Mpa
Maximum Allowable Suction Pressure	1.7 Mpa
Maximum Allowable Discharge Pressure	4.0 Mpa

Note:

Recommended operating temperature: 41°F to 100°F. The dehumidifier may experience malfunctions outside of this temperature range.

The manufacturer reserves the right to modify the product without formal notice to the public.

WARNING:

This product can expose you to chemicals including styrene and its compounds, which are known to the State of California to cause cancer or birth defects or other reproductive harm. For more information go to www.P65Warnings.ca.gov.

Important:

This warning is legally required by California's Proposition 65, which mandates disclosure even for trace amounts of certain substances. The warning does not indicate that the product is unsafe when used as intended; the risk primarily applies to long-term exposure to significant amounts of these substances. The levels in this product are negligible and within safe limits.

MAINTENANCE & CLEANING

Note: Please remember to unplug the dehumidifier first before servicing or cleaning the unit.

Exterior Cleaning

Use a soft, damp cloth to wipe clean the dust buildup on the surface of the dehumidifier. Neutral detergents are acceptable for cleaning, but avoid abrasive cleaners or harsh chemicals as they may damage the finish of the casing.

Please do not spray water directly on the device as the dehumidifier isn't waterproof. Pay special attention to the air inlets and outlets to remove any dust or debris buildup that could obstruct airflow.

Filter Cleaning

The dehumidifier comes with a removable filter. Regularly cleaning the filter helps remove dust, smoke, pet dander, mold spores, and pollen, reducing airborne allergens and improving dehumidifying efficiency.

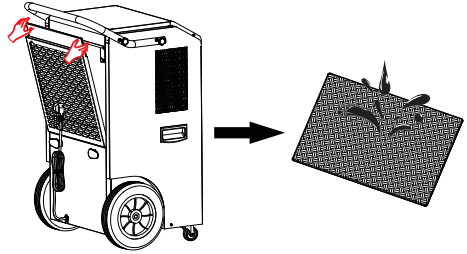

1. Insert your fingers into the openings at the top corners of the back panel and pull forcefully to remove the panel. Be careful not to pinch your fingers in the process.
2. Remove the filter from the back panel.
3. Brush off any dust and debris from the filter, rinse it thoroughly, and let it dry. Avoid drying it in direct sunlight to prevent deformation.

Note: Do NOT operate the dehumidifier without the filter in place, as dust buildup may damage the internal components.

Device Storage

While it's recommended to run the dehumidifier year-round for a comfortable environment, follow these steps for proper storage during extended periods of non-use to preserve performance and lifespan.

MAINTENANCE & CLEANING

1. Firstly, unplug the unit and allow it to cool.
2. Detach the drain hose, and clean the drain port.
3. Clean and dry the filter.
4. Wrap the power cord neatly around the cord hangers.
5. Cover the device with a breathable cloth to protect it from dust.
6. Store it in a dry and well-ventilated place, away from direct sunlight.

Warnings Regarding the Safe Use of R32 Refrigerant



**Refrigerant
Safety Group A2L**

This dehumidifier contains R32, a flammable refrigerant. All operators or maintenance personnel for refrigeration systems must hold a valid certificate from an industry-recognized body for the safe disposal of refrigerants. Repairs and maintenance should strictly adhere to the manufacturer's guidelines. If additional help is required, ensure it's under the supervision of personnel qualified in handling combustible refrigerants.

- **WARNING – Risk of Fire. Flammable Refrigerant Used. To Be Repaired Only By Trained Service Personnel. Do Not Puncture Refrigerant Tubing.**
- **WARNING – Risk of Fire. Dispose of Properly In Accordance With Federal Or Local Regulations. Flammable Refrigerant Used.**
- **WARNING – Risk of Fire. Flammable Refrigerant Used. Consult Repair Manual/Owner's Guide Before Attempting To Service This Product. All Safety Precautions Must Be Followed.**
- **WARNING – Risk of Fire due to Flammable Refrigerant Used. Follow Handling Instructions Carefully in Compliance with National Regulations.**
- **WARNING – Risk of Fire or Explosion – Store in a Well-Ventilated Room Without Continuously Operating Flames or Other Potential Ignition Sources.**
- **WARNING – Risk of Fire – Auxiliary Devices Which May Be Ignition Sources Shall Not Be Installed in the Ductwork, Other Than Auxiliary Devices Listed for Use With the Specific Appliance. See Instructions.**
- **WARNING – Risk of Fire – The Appliance Shall Be Installed, Operated, and Stored in a Room With a Floor Area Larger Than 5 m² (54 ft²).**

MAINTENANCE & CLEANING

Transportation, marking and storage for units that employ flammable refrigerants

1. General

The following information is provided for units that employ FLAMMABLE REFRIGERANTS.

2. Transport of equipment containing flammable refrigerants

Attention is drawn to the fact that additional transportation regulations may exist with respect to equipment containing flammable gas. The maximum number of pieces of equipment or the configuration of the equipment permitted to be transported together will be determined by the applicable transport regulations.

3. Marking of equipment using signs

Signs for similar appliances used in a work area are generally addressed by local regulations and give the minimum requirements for the provision of safety and/or health signs for a work location. All required signs are to be maintained and employers should ensure that employees receive suitable and sufficient instruction and training on the meaning of appropriate safety signs and the actions that need to be taken in connection with these signs.

The effectiveness of signs should not be diminished by too many signs being placed together. Any pictograms used should be as simple as possible and contain only essential details.

4. Disposal of equipment using flammable refrigerants

See national regulations.

5. Storage of equipment/appliances

The storage of the appliance should be in accordance with the applicable regulations or instructions, whichever is more stringent.

6. Storage of packed (unsold) equipment

Storage package protection should be constructed in such a way that mechanical damage to the equipment inside the package will not cause a leak of the REFRIGERANT CHARGE.

The maximum number of pieces of equipment permitted to be stored together will be determined by local regulations.

Requirements for operation, service and installation manuals of appliances using flammable refrigerants

Qualification of workers

The manual shall contain specific information about the required qualification of the working personnel for maintenance, service and repair operations. Every working procedure that affects safety means shall only be carried out by competent persons.

Examples for such working procedures are:

- breaking into the refrigerating circuit;
- opening of sealed components;

Competence of service personnel

1. General

Information of procedures additional to usual information for refrigerating appliance installation, repair, maintenance and decommission procedures is required when an appliance with FLAMMABLE REFRIGERANT is affected.

The training of these procedures is carried out by national training organisations or manufacturers that are accredited to teach the relevant national competency standards that may be set in legislation.

The achieved competence should be documented by a certificate.

MAINTENANCE & CLEANING

2. Information and training

- 2.1) The training should include the substance of the following.
- 2.2) Information about the explosion potential of FLAMMABLE REFRIGERANTS to show that flammables may be dangerous when handled without care.
- 2.3) Information about POTENTIAL IGNITION SOURCES, especially those that are not obvious, such as lighters, light switches, vacuum cleaners, electric heaters.
- 2.4) Information about the different safety concepts:
 - Unventilated-Safety of the appliance does not depend on ventilation of the housing.
 - Switching off the appliance or opening of the housing has no significant effect on the safety.
 - Nevertheless, it is possible that leaking refrigerant may accumulate inside the enclosure and flammable atmosphere will be released when the enclosure is opened.
 - Ventilated enclosure-Safety of the appliance depends on ventilation of the housing.
 - Switching off the appliance or opening of the enclosure has a significant effect on the safety.
 - Care should be taken to ensure sufficient ventilation before.
 - Ventilated room -Safety of the appliance depends on the ventilation of the room.
 - Switching off the appliance or opening of the housing has no significant effect on the safety.
 - The ventilation of the room shall not be switched off during repair procedures.
- 2.5) Information about refrigerant detectors:
 - Principle of function, including influences on the operation.
 - Procedures, how to repair, check or replace a refrigerant detector or parts of it in a safe way.
 - Procedures, how to disable a refrigerant detector in case of repair work on the refrigerant carrying parts.
- 2.6) Information about the concept of sealed components and sealed enclosures according to IEC60079-15:2010.
- 2.7) Information about the correct working procedures:
 - a) Commissioning
 - Ensure that the floor area is sufficient for the REFRIGERANT CHARGE or that the ventilation duct is assembled in a correct manner.
 - Connect the pipes and carry out a leak test before charging with refrigerant.
 - Check safety equipment before putting into service.
 - b) Maintenance
 - Portable equipment shall be repaired outside or in a workshop specially equipped for servicing units with FLAMMABLE REFRIGERANTS.
 - Ensure sufficient ventilation at the repair place.
 - Be aware that malfunction of the equipment may be caused by refrigerant loss and a refrigerant leak is possible.
 - Discharge capacitors in a way that won't cause any spark. The standard procedure to short circuit the capacitor terminals usually creates sparks.
 - Reassemble sealed enclosures accurately. If seals are worn, replace them.
 - Check safety equipment before putting into service.
 - c) Repair
 - Portable equipment shall be repaired outside or in a workshop specially equipped for servicing units with FLAMMABLE REFRIGERANTS.
 - Ensure sufficient ventilation at the repair place.
 - Be aware that malfunction of the equipment may be caused by refrigerant loss and a refrigerant leak is possible.

MAINTENANCE & CLEANING

- Discharge capacitors in a way that won't cause any spark.
- When brazing is required, the following procedures shall be carried out in the right order:
Remove the refrigerant. If the recovery is not required by national regulations, drain the refrigerant to the outside. Take care that the drained refrigerant will not cause any danger. In doubt, one person should guard the outlet. Take special care that drained refrigerant will not float back into the building.
- Evacuate the refrigerant circuit.
- Purge the refrigerant circuit with nitrogen for 5 min (not required for A2L REFRIGERANTS).
- Evacuate again (not required for A2L REFRIGERANTS).
- Remove parts to be replaced by cutting, not by flame.
- Purge the braze point with nitrogen during the brazing procedure.
- Carry out a leak test before charging with refrigerant.
- Reassemble sealed enclosures accurately. If seals are worn, replace them.
- Check safety equipment before putting into service.

d) Disposal

- Ensure sufficient ventilation at the working place.
- Remove the refrigerant. If the recovery is not required by national regulations, drain the refrigerant to the outside. Take care that the drained refrigerant will not cause any danger. In doubt, one person should guard the outlet. Take special care that drained refrigerant will not float back into the building.
- When flammable refrigerants are used,
 - evacuate the refrigerant circuit.
 - purge the refrigerant circuit with oxygen free nitrogen.
 - evacuate again. (not required for A2L refrigerants);
 - cut out the compressor and drain the oil.

Information on servicing

1. General

The manual shall contain specific information for service personnel according.

2. Checks to the area

Prior to beginning work on systems containing FLAMMABLE REFRIGERANTS, safety checks are necessary to ensure that the risk of ignition is minimised.

For repair to the REFRIGERATING SYSTEM

3. Work procedure

Work shall be undertaken under a controlled procedure so as to minimise the risk of a flammable gas or vapour being present while the work is being performed.

4. General work area

All maintenance staff and others working in the local area shall be instructed on the nature of work being carried out. Work in confined spaces shall be avoided.

5. Checking for presence of refrigerant

The area shall be checked with an appropriate refrigerant detector prior to and during work, to ensure the technician is aware of potentially toxic or flammable atmospheres. Ensure that the leak detection equipment being used is suitable for use with all applicable refrigerants, i. e. non-sparking, adequately sealed or intrinsically safe.

MAINTENANCE & CLEANING

6. Presence of fire extinguisher

If any hot work is to be conducted on the refrigerating equipment or any associated parts, appropriate fire extinguishing equipment shall be available to hand. Have a dry powder or CO₂ fire extinguisher adjacent to the charging area.

a) Commissioning

- Ensure that the floor area is sufficient for the REFRIGERANT CHARGE or that the ventilation duct is assembled in a correct manner.
- Connect the pipes and carry out a leak test before charging with refrigerant.
- Check safety equipment before putting into service.

b) Maintenance

- Portable equipment shall be repaired outside or in a workshop specially equipped for servicing units with FLAMMABLE REFRIGERANTS.
- Ensure sufficient ventilation at the repair place.
- Be aware that malfunction of the equipment may be caused by refrigerant loss and a refrigerant leak is possible.
- Discharge capacitors in a way that won't cause any spark. The standard procedure to short circuit the capacitor terminals usually creates sparks.
- Reassemble sealed enclosures accurately. If seals are worn, replace them.
- Check safety equipment before putting into service.

c) Repair

- Portable equipment shall be repaired outside or in a workshop specially equipped for servicing units with FLAMMABLE REFRIGERANTS.
- Ensure sufficient ventilation at the repair place.
- Be aware that malfunction of the equipment may be caused by refrigerant loss and a refrigerant leak is possible.
- Discharge capacitors in a way that won't cause any spark.
- When brazing is required, the following procedures shall be carried out in the following order:
--Safely remove the refrigerant following local and national regulations. If the recovery is not required by national regulations, drain the refrigerant to the outside. Take care that the drained refrigerant will not cause any danger. In doubt, one person should guard the outlet. Take special care that drained refrigerant will not float back into the building;

d) Decommissioning

- If the safety is affected when the equipment is putted out of service, the REFRIGERANT CHARGE shall be removed before decommissioning.
- Ensure sufficient ventilation at the equipment location.
- Be aware that malfunction of the equipment may be caused by refrigerant loss and a refrigerant leak is possible.
- Discharge capacitors in a way that won't cause any spark.
- Remove the refrigerant. If the recovery is not required by national regulations, drain the refrigerant to the outside. Take care that the drained refrigerant will not cause any danger. In doubt, one person should guard the outlet. Take special care that drained refrigerant will not float back into the building.
- When FLAMMABLE REFRIGERANTS except A2L REFRIGERANTS are used,
--Evacuate the refrigerant circuit.

MAINTENANCE & CLEANING

7. No ignition sources

No person carrying out work in relation to a REFRIGERATING SYSTEM which involves exposing any pipe work shall use any sources of ignition in such a manner that it may lead to the risk of fire or explosion. All possible ignition sources, including cigarette smoking, should be kept sufficiently far away from the site of installation, repairing, removing and disposal, during which refrigerant can possibly be released to the surrounding space. Prior to work taking place, the area around the equipment is to be surveyed to make sure that there are no flammable hazards or ignition risks. "No Smoking" signs shall be displayed.

8. Ventilated area

Ensure that the area is in the open or that it is adequately ventilated before breaking into the system or conducting any hot work. A degree of ventilation shall continue during the period that the work is carried out. The ventilation should safely disperse any released refrigerant and preferably expel it externally into the atmosphere.

9. Checks to the refrigerating equipment

Where electrical components are being changed, they shall be fit for the purpose and to the correct specification. At all times the manufacturer's maintenance and service guidelines shall be followed. If in doubt, consult the manufacturer's technical department for assistance. The following checks shall be applied to installations using.

FLAMMABLE REFRIGERANTS:

- the actual REFRIGERANT CHARGE is in accordance with the room size within which the refrigerant containing parts are installed;
- the ventilation machinery and outlets are operating adequately and are not obstructed;
- if an indirect refrigerating circuit is being used, the secondary circuit shall be checked for the presence of refrigerant;
- marking to the equipment continues to be visible and legible. Markings and signs that are illegible shall be corrected;
- refrigerating pipe or components are installed in a position where they are unlikely to be exposed to any substance which may corrode refrigerant containing components, unless the components are constructed of materials which are inherently resistant to being corroded or are suitably protected against being so corroded.

10. Checks to electrical devices

Repair and maintenance to electrical components shall include initial safety checks and component inspection procedures. If a fault exists that could compromise safety, then no electrical supply shall be connected to the circuit until it is satisfactorily dealt with. If the fault cannot be corrected immediately but it is necessary to continue operation, an adequate temporary solution shall be used. This shall be reported to the owner of the equipment so all parties are advised.

Initial safety checks shall include:

- that capacitors are discharged: this shall be done in a safe manner to avoid possibility of sparking;
- that no live electrical components and wiring are exposed while charging, recovering or purging the system;
- that there is continuity of earth bonding.

MAINTENANCE & CLEANING

11. Repairs to sealed components

1) During repairs to sealed components, all electrical supplies shall be disconnected from the equipment being worked upon prior to any removal of sealed covers, etc. If it is absolutely necessary to have an electrical supply to equipment during servicing, then a permanently operating form of leak detection shall be located at the most critical point to warn of a potentially hazardous situation.

2) Sealed electrical components shall be replaced.

12. Repair to intrinsically safe components

Do not apply any permanent inductive or capacitance loads to the circuit without ensuring that this will not exceed the permissible voltage and current permitted for the equipment in use. Intrinsically safe components must be replaced.

Replace components only with parts specified by the manufacturer. Other parts may result in the ignition of refrigerant in the atmosphere from a leak.

13. Cabling

Check that cabling will not be subject to wear, corrosion, excessive pressure, vibration, sharp edges or any other adverse environmental effects. The check shall also take into account the effects of aging or continual vibration from sources such as compressors or fans.

14. Detection of flammable refrigerants

Under no circumstances shall potential sources of ignition be used in the searching for or detection of refrigerant leaks. A halide torch (or any other detector using a naked flame) shall not be used. The following leak detection methods are deemed acceptable for all refrigerant systems. Electronic leak detectors may be used to detect refrigerant leaks but, in the case of FLAMMABLE REFRIGERANTS, the sensitivity may not be adequate, or may need re-calibration. (Detection equipment shall be calibrated in a refrigerant-free area.)

Ensure that the detector is not a potential source of ignition and is suitable for the refrigerant used.

Leak detection equipment shall be set at a percentage of the LFL of the refrigerant and shall be calibrated to the refrigerant employed, and the appropriate percentage of gas (25 % maximum) is confirmed.

Leak detection fluids are also suitable for use with most refrigerants but the use of detergents containing chlorine shall be avoided as the chlorine may react with the refrigerant and corrode the copper pipe-work.

If a leak is suspected, all naked flames shall be removed/extinguished.

If a leakage of refrigerant is found which requires brazing, all of the refrigerant shall be recovered from the system, or isolated (by means of shut off valves) in a part of the system remote from the leak. Removal of refrigerant shall be according to Removal and evacuation.

15. Removal and evacuation

When breaking into the refrigerant circuit to make repairs -or for any other purpose- conventional procedures shall be used. However, for flammable refrigerants it is important that best practice be followed, since flammability is a consideration.

MAINTENANCE & CLEANING

The following procedure shall be adhered to:

- safely remove refrigerant following local and national regulations;
- purge the circuit with inert gas(optional for A2L);
- evacuate(optional for A2L);
- continuously flush or purge with inert gas when using flame to open circuit ; and
- open the circuit.

The refrigerant charge shall be recovered into the correct recovery cylinders if venting is not allowed by local and national codes. For appliances containing flammable refrigerants, the system shall be purged with oxygen-free nitrogen to render the appliance safe for flammable refrigerants. This process might need to be repeated several times. Compressed air or oxygen shall not be used for purging refrigerant systems. For appliances containing flammable refrigerants, refrigerants purging shall be achieved by breaking the vacuum in the system with oxygen-free nitrogen and continuing to fill until the working pressure is achieved, then venting to atmosphere, and finally pulling down to a vacuum (optional for A2L). This process shall be repeated until no refrigerant is within the system (optional for A2L). When the final oxygen-free nitrogen charge is used, the system shall be vented down to atmospheric pressure to enable work to take place.

The outlet for the vacuum pump shall not be close to any potential ignition sources, and ventilation shall be available.

16. Charging procedures

In addition to conventional charging procedures, the following requirements shall be followed.

- Ensure that contamination of different refrigerants does not occur when using charging equipment. Hoses or lines shall be as short as possible to minimise the amount of refrigerant contained in them.
- Cylinders shall be kept in an appropriate position according to the instructions.
- Ensure that the REFRIGERATING SYSTEM is earthed prior to charging the system with refrigerant.
- Label the system when charging is complete (if not already).
- Extreme care shall be taken not to overfill the REFRIGERATING SYSTEM. Prior to recharging the system, it shall be pressure-tested with the appropriate purging gas. The system shall be leak-tested on completion of charging but prior to commissioning. A follow up leak test shall be carried out prior to leaving the site.

17. Decommissioning

Before carrying out this procedure, it is essential that the technician is completely familiar with the equipment and all its detail. It is recommended good practice that all refrigerants are recovered safely. Prior to the task being carried out, an oil and refrigerant sample shall be taken in case analysis is required prior to re-use of recovered refrigerant.

It is essential that electrical power is available before the task is commenced.

- a) Become familiar with the equipment and its operation.
- b) Isolate system electrically.
- c) Before attempting the procedure, ensure that:

MAINTENANCE & CLEANING

- Mechanical handling equipment is available, if required, for handling refrigerant cylinders;
- All personal protective equipment is available and being used correctly;
- The recovery process is supervised at all times by a competent person;
- Recovery equipment and cylinders conform to the appropriate standards.

d) Pump down refrigerant system, if possible.

e) If a vacuum is not possible, make a manifold so that refrigerant can be removed from various parts of the system.

f) Make sure that cylinder is situated on the scales before recovery takes place.

g) Start the recovery machine and operate in accordance with instructions.

h) Do not overfill cylinders (no more than 80 % volume liquid charge).

i) Do not exceed the maximum working pressure of the cylinder, even temporarily.

j) When the cylinders have been filled correctly and the process completed, make sure that the cylinders and the equipment are removed from site promptly and all isolation valves on the equipment are closed off.

k) Recovered refrigerant shall not be charged into another REFRIGERATING SYSTEM unless it has been cleaned and checked.

18. Labelling

Equipment shall be labelled stating that it has been de-commissioned and emptied of refrigerant. The label shall be dated and signed. For appliances containing FLAMMABLE REFRIGERANTS, ensure that there are labels on the equipment stating the equipment contains FLAMMABLE REFRIGERANT.

19. Recovery

When removing refrigerant from a system, either for servicing or decommissioning, it is recommended good practice that all refrigerants are removed safely. When transferring refrigerant into cylinders, ensure that only appropriate refrigerant recovery cylinders are employed. Ensure that the correct number of cylinders for holding the total system charge is available. All cylinders to be used are designated for the recovered refrigerant and labelled for that refrigerant (i. e. special cylinders for the recovery of refrigerant). Cylinders shall be complete with pressure-relief valve and associated shut-off valves in good working order. Empty recovery cylinders are evacuated and, if possible, cooled before recovery occurs.

The recovery equipment shall be in good working order with a set of instructions concerning the equipment that is at hand and shall be suitable for the recovery of the flammable refrigerant. If in doubt, the manufacturer should be consulted. In addition, a set of calibrated weighing scales shall be available and in good working order. Hoses shall be complete with leak-free disconnect couplings and in good condition.

The recovered refrigerant shall be processed according to local legislation in the correct recovery cylinder, and the relevant waste transfer note arranged. Do not mix refrigerants in recovery units and especially not in cylinders.

If compressors or compressor oils are to be removed, ensure that they have been evacuated to an acceptable level to make certain that flammable refrigerant does not remain within the lubricant.

The compressor body shall not be heated by an open flame or other ignition sources to accelerate this process. When oil is drained from a system, it shall be carried out safely.

WARRANTY & CONTACT

Warranty

All Waykar products are covered under our 12-month warranty. Customers, whether purchasing directly from Waykar or through an authorized retailer, can reach out to Waykar for support. An order invoice or proof of purchase will be appreciated.

Please note that product damage caused by regular wear and tear will not be covered under warranty, and the warranty will be voided for these behaviors (including but not limited to):

1. Failing to follow the instructions in the manual.
2. Purposeful mishandling of the device.
3. Damaging the device through violent impact.
4. Exposing the device to liquids or infiltrating foreign particles.
5. Unauthorized modification or overhauling of the device.
6. Damage from placing the device upside down.

These are our general terms for warranty service. Customers are more than welcome to contact us for any feedback or advice.

Extend Your Warranty by 1 Year

Register your product at www.waykar.com to extend your 1-year warranty by an additional year.

*Please fill out all required fields and include your Order ID and Date of Purchase if applicable.

Customer Support

For any product-related queries, kindly contact our support team at Waykar. In case of missing, displaced, or damaged dehumidifier parts, you can always reach out to Waykar support for assistance.

WAYKAR Office

🏠 805 Victory Trail Rd, Gaffney, SC, 29340 USA

✉ Email: support@waykar.com

☎ Tel: **+1-(213)-895-4871**

💬 Live Chat: www.waykar.com

🕒 24/7 Full-Time Response

*Have your Order Number ready before contacting customer support.

waykar



Scan the QR code
for Live Chat



@ Waykar

We hope our products will make your living space healthier and more comfortable.

Your satisfaction is our top priority.

Feel free to tag us when you share a snap on your social media.

WAYKAR® All rights reserved.