

INSTALLATION AND MAINTENANCE



Do not install bottom of heater less than 6 ft above the floor 6 inches to side wall, 5 inches to back wall, and 2 inches to ceiling when clearance to ceiling is 2 inches. Do not point heater at ceiling.

Electronic Unit Heater

KBP ECO2S and PlatinumX unit heaters are to be operated at **voltage listed on the rating label**. It is important that you verify the power supply voltage is the same as the nameplate voltage of the heater. Connecting the heater to an improper voltage or failure to follow the procedures as outlined in this manual can result in damage to the heater and void the warranty. This heater is provided with a factory installed thermostat. Disconnect all power from the heater at the main service panel before attempting to install or service this unit. All electrical wiring must conform to local electrical codes.

⚠ WARNING ⚠

READ CAREFULLY - Use the heater only as described in this manual. Any other use is not recommended and could result in fire, electric shock, and personal injury. Following these instructions will prevent difficulties that might occur during the installation and use of the heater. Please study the instructions first, as they may save considerable time and trouble during use addition to providing important safety information. Make

Read all instructions before wiring or using this heater.

- ⚠ **WARNING** Heaters outlet grill is very hot when in use. To avoid burns, do not touch hot surfaces with bare skin. Keep combustible materials, including furniture, pillows, bedding, papers, clothes, curtains, and boxes at least 3 feet from the front of the heater and keep them away from the sides and rear.
- ⚠ **WARNING** Do not use outdoors.
- ⚠ **WARNING** Heater is not intended for use in bathrooms, laundry areas or similar indoor locations. Never locate heater where it may fall into a bathtub or other water container. Do not insert or allow foreign objects to enter any inlet or outlet openings as this may cause an electric shock, fire, or damage to the heater.
- ⚠ **WARNING** To prevent a possible of fire, do not block air intakes or exhaust in any manner.
- ⚠ **WARNING** Heater has hot surfaces. Internal thermostat and limiting parts can arc or create sparks inside. Do not use this heater in areas where gasoline, paint, or flammable liquids or gases are used or stored.
- ⚠ **WARNING** Use this heater only as described in this manual. Any other use is not recommended by the manufacturer and may cause fire, electric shock, explosion or injury to people and or property.
- ⚠ **WARNING** If heater shows signs of overheating immediately turn the circuit breaker off to the heater. Remove and inspect for any objects on or adjacent to the heater that may cause the high temperatures. Have a professional inspect the internals until the reason is clear why the heater is overheating. Do not reinstall until it has been professionally serviced.
- ⚠ **WARNING** Do not operate heater after it malfunctions. Disconnect heater at service panel and have heater inspected by a reputable electrician before reusing.
- ⚠ **WARNING** To disconnect heater, turn controls to off position, and turn off power to heater circuit at main electrical panel or operate internal disconnect switch to off if provided. Extreme caution is necessary when any heater is used by or near children or invalids and whenever the heater is left operating and unattended too.
- ⚠ **WARNING**

ASSEMBLY INSTRUCTIONS



KBP



Minimum Clearance From Combustibles

Front	18 in.
Top	2 in.
Sides	6 in.
Rear	5 in.
Floor	6 ft.

DANGER

ELECTRIC SHOCK OR FIRE HAZARD

READ ALL WIRE SIZING, VOLTAGE REQUIREMENTS AND SAFETY DATA TO AVOID PROPERTY DAMAGE AND PERSONAL INJURY

INSTALLATION INSTRUCTIONS

FOR WALL MOUNT APPLICATIONS

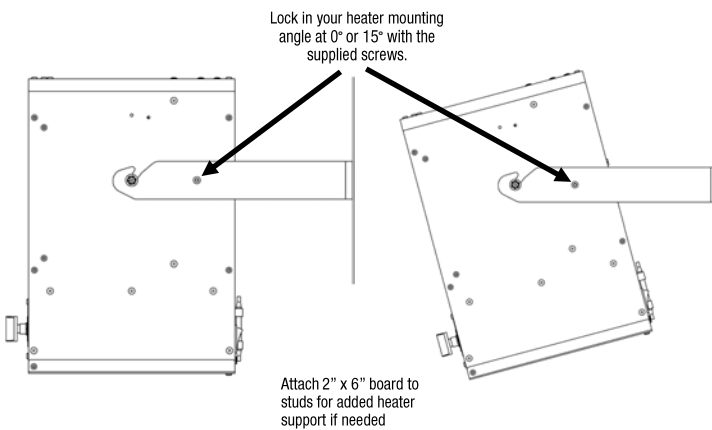

FOR CEILING MOUNT APPLICATIONS

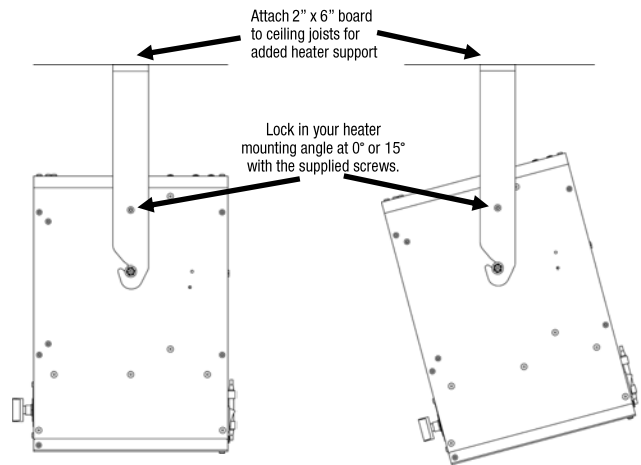

Remove heater & all packaging materials from the box.

HARDWARE NEEDED:

- Adequate gauge & length of wire for your application
- Proper size fuses or breakers to handle amperage
- Proper wire connectors for your application
- Fasteners appropriate size to mount heater

i *Tip: Be sure to remove the hardware package from the Styrofoam packaging.*

MOUNTING HEIGHT:

When the air flow of the heater is directed vertically or horizontally, the minimum mounting height is 6 feet in the USA and 8 feet in Canada. Mounting heights depend upon building utilization and heater KW capacity.

LOCATION OF HEATER:

The heater should be installed 6 feet above floor and according to minimum clearance chart. The direction of airflow should not be restricted by machinery, beams, etc., and the air flow should run with walls, rather than blowing directly at them. When more than one heater is used in an area, the heaters should be arranged so that the air discharge of each heater supports the air flow of the others to provide best circulation of warm air.

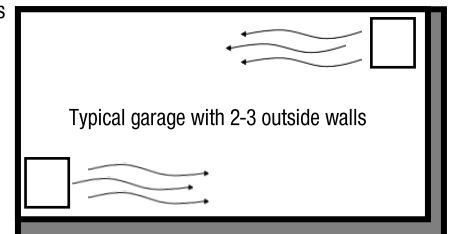

MOUNTING HEATER:

Wall stud and ceiling joists are typically wider than our mounting bracket which is 11 inches wide. The heater weighs 14 lbs. and should be mounted onto at least one stud to be properly supported.

Your fasteners penetrating a stud is critical to supporting the weight. A gypsum wall board fastener is not strong enough. If your ideal location has no solid backing, you can fasten with large screw fasteners a 2" x 6" board to ceiling joists or wall studs. Attach with appropriate lag bolts with proper depth for the 14 lbs. Install wing nut fasteners into the outside of the bracket and star washer between the heater and bracket. Be certain bracket bolts are tightened firmly to secure the heater to swivel bracket.

**For additional mounting flexibility, an optional mounting bracket is available for sale*

SAFETY INFORMATION

KBP EC02S Circuit Sizing Chart

1 PHASE CIRCUIT SIZING TABLE					
Watts (Max)	BTUH	Volts	Amps	Wire Size	Circuit Protection
			1 Phase		
950	3242	120	7.9	#14/2	15A-1P
		208	4.6	#14/2	15A-2P
		240	4.0	#14/2	15A-2P
1900	6485	120	15.8	#12/2	20A-1P
		208	9.1	#14/2	15A-2P
		240	7.9	#14/2	15A-2P
2620	8942	208	12.6	#12/2	20A-2P
2850	9727	120	23.8	#10/2	30A-1P
		240	11.9	#14/2	15A-2P
3340	11399	208	16.0	#12/2	30A-2P
3800	12969	240	15.8	#12/2	20A-2P
4290	14642	208	20.6	#10/2	30A-2P
4750	16212	240	19.8	#10/2	30A-2P
5010	17065	208	24	#10/2	30A-2P
5700	19454	240	23.8	#10/2	30A-2P

KBP PlatinumX Circuit Sizing Chart

1 PHASE CIRCUIT SIZING TABLE					
Watts (Max)	BTUH	Volts	Amps	Wire Size	Circuit Protection
			1 Phase		
950	3242	277	3.4	#14/2	15A-2P
1900	6485	277	6.9	#14/2	15A-2P
2850	9727	277	10.3	#14/2	15A-2P
3800	12969	277	13.7	#14/2	15A-2P
4750	16212	277	17.1	#10/2	30A-2P
5700	19454	277	20.6	#10/2	30A-2P
3 PHASE CIRCUIT SIZING TABLE					
Watts (Max)	BTUH	Volts	Amps	Wire Size	Circuit Protection
			3 Phase		
2850	9727	208	7.9	#14/3	15A-3P
		240	6.9		
		480	3.4		
5010	17065	208	13.9	#12/3	20A-3P
5700	19454	240	13.7	#12/3	20A-3P
		480	6.9	#14/3	15A-3P

WARNING: Prior to operating, make sure the circuit breaker is of the configuration and capacity appropriate for the heater.

IMPORTANT: Per the National Electrical Code heating circuits are considered a continuous load and therefore must be de-rated by 20%.

For example, a 20 amp heating circuit can not have more than 16 amps of connected load.

- Minimum installed distance from the heater to the adjoining wall or ceiling surfaces - 5 inches to back wall.
- When clearance to ceiling is 2 inches, Do Not Point Heater At Ceiling.
- Use extreme caution when used near children or people with disabilities.
- Do not use outdoors.
- Not intended for use in bathrooms, laundry areas or other similar wet locations. Never locate heater where it may have contact with water.
- Do not use heater in wet or moist locations.
- Don't place heater against cardboard or low-density fiberboard surfaces.
- Avoid using an extension cord because the extension cord may overheat and cause a risk of fire.
- Use only the electrical power (voltage and frequency) specified on the model plate of the heater.
- Keep all combustible materials away from this heater.

LOUVER ADJUSTMENT TO DIRECT AIRFLOW

The louvers are opened during testing at factory, but may have shifted during shipping. Confirm louvers are rotated less than 45 degrees from horizontal before operation. To adjust the opening angle, grasp the left and right end of louver and twist with two hands to the desired position.

CAUTION: Increasing angle beyond 45° degrees from horizontal may restrict air flow casing over temperature limit to activate & shut off the heater.

Louver Adjustment

Do Not Adjust While Heater Is Operational

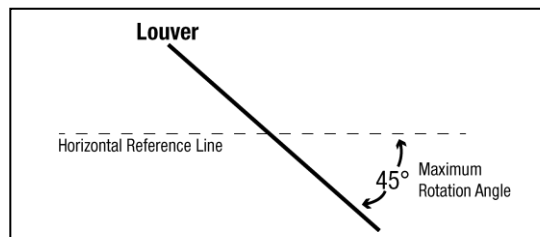

DIMENSIONAL DATA

Dimensional Data

Minimum clearance from combustibles: 18" from front, 2" from top, 6" from sides and 5" from rear. Minimum clearance 6' from floor.

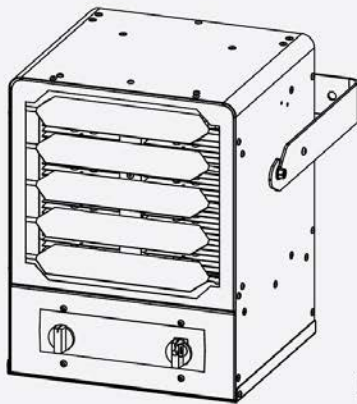

Note: Optional Heat/Fan/Disconnect Switch Shown.

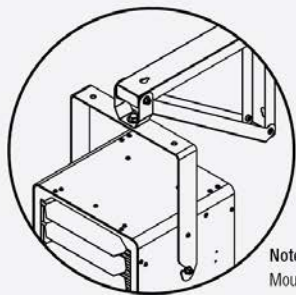

Note: Optional Swivel Mounting Bracket

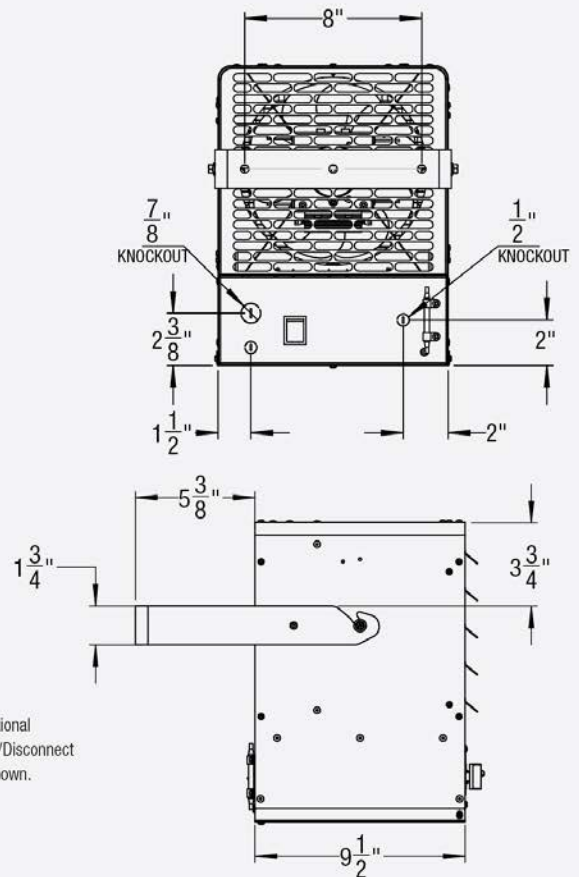
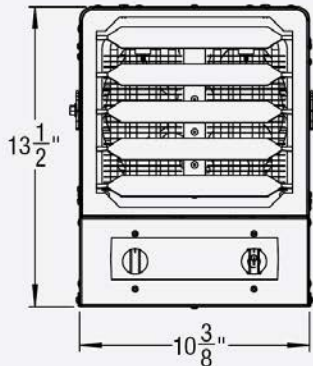

Note: Optional Heat/Fan/Disconnect Switch Shown.

WIRING INSTRUCTIONS



WARNING Before proceeding further with the installation of this heater, turn off the power and lock the supply line for the heater at the main service box.

WIRING INSTRUCTIONS

1. Remove wiring compartment cover.
2. Remove one of the knock outs from the back of the unit. It is not necessary to remove the grill cover.
3. Size service wire to adequately handle amp load of the heater. Refer to the Circuit Sizing Table for proper wire size and circuit protection.
4. Connect supply wire to L1 & L2 & L3 as applicable as shown in the wiring diagrams provided with heater.
5. Secure power supply cable with cable clamp.
6. Connect ground wire to the ground lug.
7. Adjust the heater to the desired position.

Note: Power must land at heater uninterrupted by switches or thermostat due to thermal fan delay

Field-Adjustable Wattages

Pic-A-Watt® Heating Element Exclusive King multi-tap element allows field adjustment to several wattages at time of installation.

Reference the wiring diagram when adjusting the wattage. The below tables should be used as a supplement to your wiring diagram.

Element End View for 3 Phase “-3MP” Models

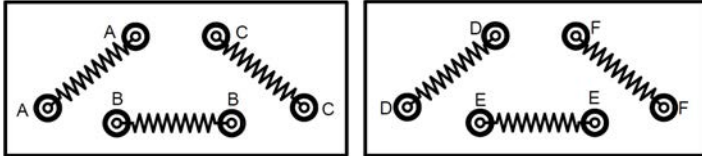

Element End View for Single Phase “-1” Models

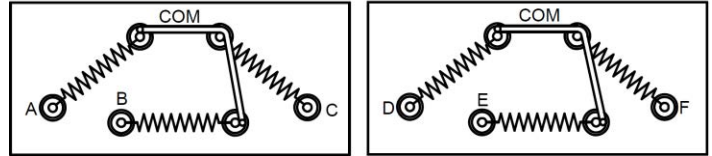

Single phase models have a welded busbar connecting all element commons together. This is depicted by “COM” in the diagram above. There is only 1 connection point for the “COM” common connection. This will not be removed when adjusting the wattages.

king KBP1230-1-MB-ECO2S				120V - 2850W	STAGE 1 ELEMENT LEADS REMOVED TO GET SELECTABLE WATTAGES	STAGE 1 SELECTABLE WATTAGES	
REMOVE ELEMENT POSITION	HEAT STAGE	ELEMENT WIRE COLOR	WATTAGE REDUCTION				
ELEMENT 1 - 120V - 1425W							
A	STAGE 1	RED	712		NONE	1900	
B	STAGE 2	RED/WHITE	475		C	1662	
C	STAGE 1	RED	238		C & F	1425	
ATTENTION :DO NOT REMOVE BLACK E1 COM OR E2 COM WIRES ATTACHED TO BUSBAR ON EACH ELEMENT					A & F	950	
ELEMENT 2 - 120V - 1425W					A & D	475	
D	STAGE 1	YELLOW	712		STAGE 2 ELEMENT LEADS REMOVED TO GET SELECTABLE WATTAGES	STAGE 2 SELECTABLE WATTAGES	
E	STAGE 2	RED/WHITE	475		NONE	950	
F	STAGE 1	RED	238	E	475		

king KBP2005-1-MB-ECO2S				208V - 5010W	STAGE 1 ELEMENT LEADS REMOVED TO GET SELECTABLE WATTAGES	STAGE 1 SELECTABLE WATTAGES	
REMOVE ELEMENT POSITION	HEAT STAGE	ELEMENT WIRE COLOR	WATTAGE REDUCTION				
ELEMENT 1 - 208V - 2850W							
A	STAGE 1	RED	950		NONE	3230	
B	STAGE 2	RED/WHITE	950		D	2510	
C	STAGE 1	RED	950		A	2280	
ATTENTION :DO NOT REMOVE BLACK E1 COM OR E2 COM WIRES ATTACHED TO BUSBAR ON EACH ELEMENT					A & D	1560	
ELEMENT 2 - 240V - 2850W [2250W @ 208V]					STAGE 2 ELEMENT LEADS REMOVED TO GET SELECTABLE WATTAGES	STAGE 2 SELECTABLE WATTAGES	
D	STAGE 1	YELLOW	720		NONE	1670	
E	STAGE 2	RED/WHITE	720		E	950	
F	STAGE 1	RED	720	B	720		

king KBP2406-1-MB-ECO2S				240V - 5700W	STAGE 1 ELEMENT LEADS REMOVED TO GET SELECTABLE WATTAGES	STAGE 1 SELECTABLE WATTAGES	
REMOVE ELEMENT POSITION	HEAT STAGE	ELEMENT WIRE COLOR	WATTAGE REDUCTION				
ELEMENT 1 - 240V - 2850W							
A	STAGE 1	RED	950		NONE	1900	
B	STAGE 2	RED/WHITE	950		C	1662	
C	STAGE 1	RED	950		C & F	1425	
ATTENTION :DO NOT REMOVE BLACK E1 COM OR E2 COM WIRES ATTACHED TO BUSBAR ON EACH ELEMENT					A & F	950	
ELEMENT 2 - 240V - 2850W					A & D	475	
D	STAGE 1	YELLOW	720		STAGE 2 ELEMENT LEADS REMOVED TO GET SELECTABLE WATTAGES	STAGE 2 SELECTABLE WATTAGES	
E	STAGE 2	RED/WHITE	720		NONE	950	
F	STAGE 1	RED	720	E	475		

Field-Adjustable Wattages (Cont.)

Pic-A-Watt® Heating Element Exclusive King multi-tap element allows field adjustment to several wattages at time of installation.

Reference the wiring diagram when adjusting the wattage. The below tables should be used as a supplement to your wiring diagram.

king KBP2005-3MP-MB-PLTMX					
REMOVE ELEMENT POSITION	ELEMENT WIRE COLOR	WATTAGE REDUCTION	208V - 5010W - 3MP 3-PH	ELEMENT LEADS REMOVED TO GET SELECTABLE WATTAGES	SELECTABLE WATTAGES
ELEMENT 1 - 208V - 2850W					
A	YELLOW	720			
B	ORANGE	720			
C	RED	720	NONE	5010	
			A & C & E	2390	
ELEMENT 2 - 240V - 2850W [2250W @ 208V]					
D	YELLOW	950			
E	ORANGE	950			
F	RED	950			

king KBP2005-1MP-MB-PLTMX*					
REMOVE ELEMENT POSITION	ELEMENT WIRE COLOR	WATTAGE REDUCTION	208V - 5010W - 3MP 1-PH	ELEMENT LEADS REMOVED TO GET SELECTABLE WATTAGES	SELECTABLE WATTAGES
ELEMENT 1 - 208V - 2850W					
A	YELLOW	720			
B	ORANGE	720			
C	RED	720	NONE	5010	
			F	4060	
			B & E	3340	
			B & D & E	2390	
			B & C & E & F	1670	
ELEMENT 2 - 240V - 2850W [2250W @ 208V]			*THIS IS THE CONVERTED TO 1-PH VERSION OF THIS MULTIPHASE MODEL		
D	YELLOW	950			
E	ORANGE	950			
F	RED	950			

king KBP2406-3MP-MB-PLTMX					
REMOVE ELEMENT POSITION	ELEMENT WIRE COLOR	WATTAGE REDUCTION	240V - 5700W - 3MP 3-PH	ELEMENT LEADS REMOVED TO GET SELECTABLE WATTAGES	SELECTABLE WATTAGES
ELEMENT 1 - 240V - 2850W					
A	YELLOW	950			
B	ORANGE	950			
C	RED	950	NONE	5700	
			A & C & E	2850	
ELEMENT 2 - 240V - 2850W					
D	YELLOW	950			
E	ORANGE	950			
F	RED	950			

king KBP2406-1MP-MB-PLTMX*					
REMOVE ELEMENT POSITION	ELEMENT WIRE COLOR	WATTAGE REDUCTION	240V - 5700W - 3MP 1-PH	ELEMENT LEADS REMOVED TO GET SELECTABLE WATTAGES	SELECTABLE WATTAGES
ELEMENT 1 - 240V - 2850W					
A	YELLOW	950			
B	ORANGE	950			
C	RED	950	NONE	5700	
			A	4750	
			A & F	3800	
			B & D & F	2850	
			A & C & D & F	1900	
ELEMENT 2 - 240V - 2850W			*THIS IS THE CONVERTED TO 1-PH VERSION OF THIS MULTIPHASE MODEL		
D	YELLOW	950			
E	ORANGE	950			
F	RED	950			

king KBP2706-1-MB-PLTMX					
REMOVE ELEMENT POSITION	ELEMENT WIRE COLOR	WATTAGE REDUCTION	277V - 5700W	ELEMENT LEADS REMOVED TO GET SELECTABLE WATTAGES	SELECTABLE WATTAGES
ELEMENT 1 - 277V - 2850W					
A	RED	950			
B	BLUE	950			
C	RED	950	NONE	5700	
			A	4750	
			A & F	3800	
			B & D & F	2850	
			B & D & F	1900	
ELEMENT 2 - 277V - 2850W					
D	YELLOW	950			
E	ORANGE	950			
F	RED	950			

king KBP4806-3MP-PLTMX					
REMOVE ELEMENT POSITION	ELEMENT WIRE COLOR	WATTAGE REDUCTION	480V - 5700W - 3MP 3-PH	ELEMENT LEADS REMOVED TO GET SELECTABLE WATTAGES	SELECTABLE WATTAGES
ELEMENT 1 - 480V - 2850W					
A	YELLOW	950			
B	ORANGE	950			
C	RED	950	NONE	5700	
			A & C & E	2850	
ELEMENT 2 - 480V - 2850W					
D	YELLOW	950			
E	ORANGE	950			
F	RED	950			

king KBP4806-1MP-PLTMX*					
REMOVE ELEMENT POSITION	ELEMENT WIRE COLOR	WATTAGE REDUCTION	480V - 5700W - 3MP 1-PH	ELEMENT LEADS REMOVED TO GET SELECTABLE WATTAGES	SELECTABLE WATTAGES
ELEMENT 1 - 480V - 2850W					
A	YELLOW	950			
B	ORANGE	950			
C	RED	950	NONE	5700	
			A	4750	
			A & F	3800	
			B & D & F	2850	
			A & C & D & F	1900	
ELEMENT 2 - 480V - 2850W			*THIS IS THE CONVERTED TO 1-PH VERSION OF THIS MULTIPHASE MODEL		
D	YELLOW	950			
E	ORANGE	950			
F	RED	950			

OPERATING INSTRUCTIONS

Operation



1. Push the  button, the heater will come on and heat to the default setting of 72°F.
2. Once the room temperature reaches the set point, the heat elements will turn off, followed by a 3 minute fan delay period to exhaust excess heat from the case. Afterwards the unit will turn off.
3. In normal operation the display will show the current room temperature.

Automatic 2-stage HIGH/LOW operation



Eco2S controllers offer energy efficient 2-stage heating, automatically using the lowest wattage required to heat the room.

- During operation, when the set temperature is within 3 degrees of the room temperature the heater automatically switches to ECO mode, operating at LOW wattage.



Room Temperature Selection

- During operation, push  or  arrow buttons to set the temperature from 40°F-95°F, Hold down the UP or DOWN arrow to speed up the selection process. The LCD will go back to display room temperature after 5 seconds.

Timer Mode Selection

- During operation, press the  button 1 time, the display window will show the timer mode setup. Push  or  to set Timer from 1 hour—9 hours.

Fan Only Mode Selection

- During operation, press the  button 2 times, the display window will show [H] (Heat Mode) or [F] (Fan Only Mode).
Push  or  to switch between Fan Only and Heat modes.

ECO2S Control Panel

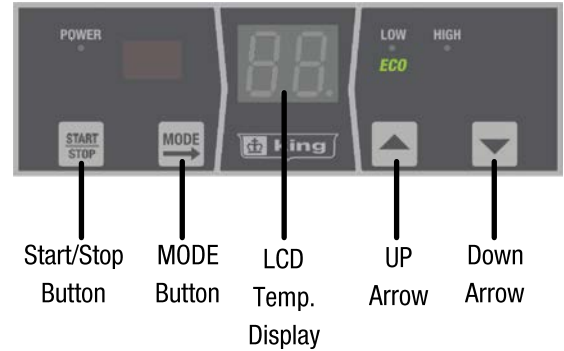

PlatinumX Control Panel

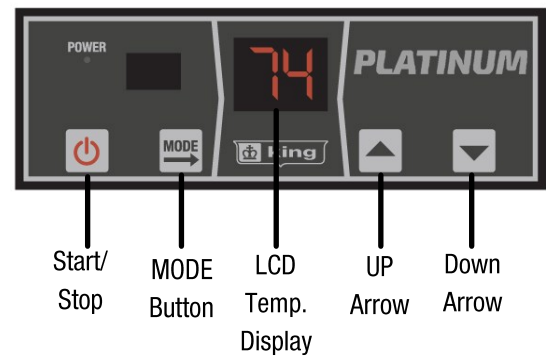

OPERATING INSTRUCTIONS CONTINUED

Display Lock Feature





Display Lock is designed for high traffic areas and deactivates the heater display buttons to prevent unwanted temperature adjustments. However settings can still be adjusted through the remote control.

- During operation, press the  button and HOLD for 5 seconds to set the display lock. [L] will appear on the display temporarily if a user attempts to make a temperature adjustment. While in Display Lock, heater can be adjusted using remote control.

Setting "Environment" Mode

Two Environment Options: Standard [SF] and Bedroom [BE].

Bedroom Mode turns off the display after 30 seconds for people using this heater in a light sensitive environment. Once any button is pressed the display turns back on.

- During operation, press the and HOLD the  and  buttons for 3 seconds. Then press  or  to select "Bedroom Mode" [BE] or "Standard Mode" [SF]

Factory Reset





- During operation, press and HOLD the  button for 5 seconds to reset to the factory settings. [FA] will flash on the display.

Sensor Error Code

- During operation, if the display shows [E1] that indicates an issue with the sensor and the sensor needs to be replaced. Contact customer support for assistance.

Setting Differential Value

The differential or gap affects how often the heater cycles. The lower the differential setting, the more the heater will cycle. If heater cycles too often, raise the differential setting to a higher degree.

- Press the and HOLD the  and  buttons for 5 seconds. The display will show the previously set differential. Press  or  to adjust the differential value between -0 to -5.

ECO2S Control Panel

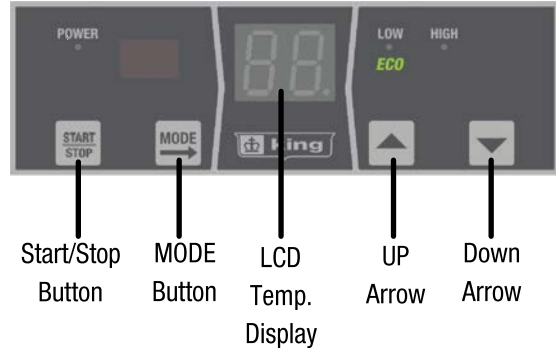

PlatinumX Control Panel

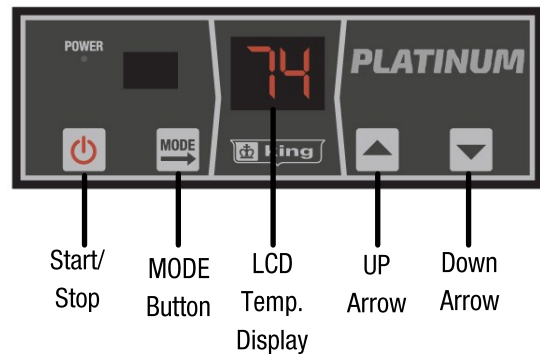

PlatinumX - CONNECTION OF OPTIONAL 24V REMOTE THERMOSTAT

Controlling PlatinumX with a Remote 24V Thermostat

KBP PlatinumX heaters come standard with the provisions to connect any 24V remote wall thermostat, for remote temperature sensing and control. Provides silent operation control for use with a 24 Volt Thermostat. Follow steps below for setup.

Step 1:

Dip Switch Selection On Display For Remote Wall Thermostat—

Local or Remote Thermostat (Figure 1)

The 2 dip switches on the back of the display are used for selecting between the onboard thermostat control and the optional remote wall thermostat control.

Set dip switch 1 to ON and dip switch 2 to the OFF position if using 24V Remote Wall Thermostat Control

24V Remote Wall Thermostat



Dip switch #1 = ON
Dip switch #2 = OFF
Remote 24V Thermostat Control

Local Thermostat (default)



Dip switch #1 = OFF
Dip switch #2 = ON
Local Thermostat Control (default)

IMPORTANT: If display shows "L5" when using a 24V remote thermostat, switch Dip Switch #1 to ON.

Step 2:

Dip Switch Selection On Controller PCB - 1-Stage or 2-Stage Thermostat (Figure 2)

Refer to the thermostat operating instructions to determine if the thermostat is a single stage or two stage thermostat.

Select the dip switch setting required.

For 1-Stage Heating > Dip Switch = ON

NOTE: PlatinumX is **ONLY** compatible with 1-Stage Thermostats

Step 3:

Wiring 24V Remote Thermostat to KB Platinum (Figure 3)

Following thermostat manufacturer's instructions.

Figure 1: Back of Display



(dip switch factory default settings shown)

Figure 2: Controller PCB

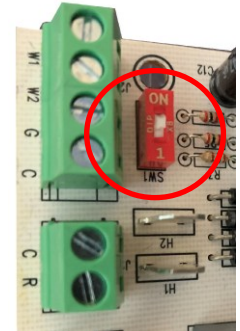

(PlatinumX: dip switch = ON required)

Figure 3: Wiring Schematic Overview

1 DISPLAY (104647)

DIP SWITCH 1

OFF = EXTERNAL SENSOR CONTROL (102806) (DEFAULT SETTING)

ON = LOCAL SENSOR CONTROL

DIP SWITCH 2

OFF = REMOTE STAT (CUSTOMER PROVIDED)

ON = LOCAL STAT (CONTROL SETTING BY DISPLAY) (DEFAULT)

CONTROL BOARD (101272)

2 DIP SWITCH LMS

ON = SINGLE STAGE REMOTE STAT (DEFAULT)

OFF = TWO STAGE REMOTE STAT

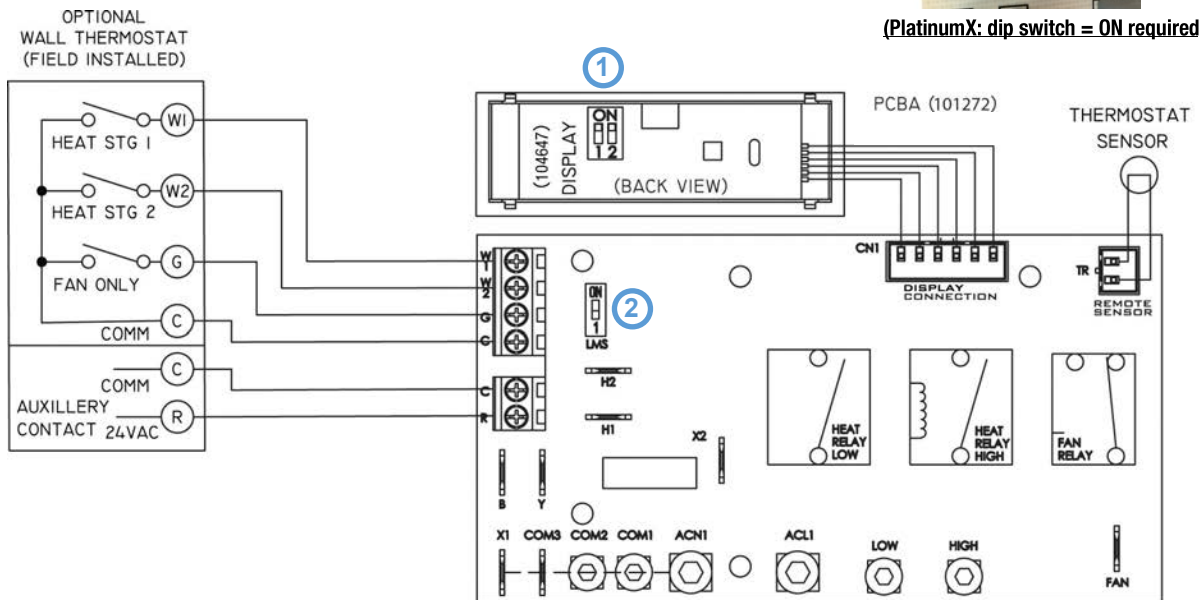

CONNECTION OF OPTIONAL NEST LEARNING THERMOSTAT



To connect a Nest Learning to PlatinumX, you will need to run multi-conductor thermostat wire between the Nest Thermostat and the PlatinumX terminal board per the wiring diagram below. Thermostat wire is a class 2 power-limited circuit cable for use in thermostat control applications.

Nest King PlatinumX

G ----- G, FAN ONLY

Conventional 1 Stage Heating **PLATINUMX**

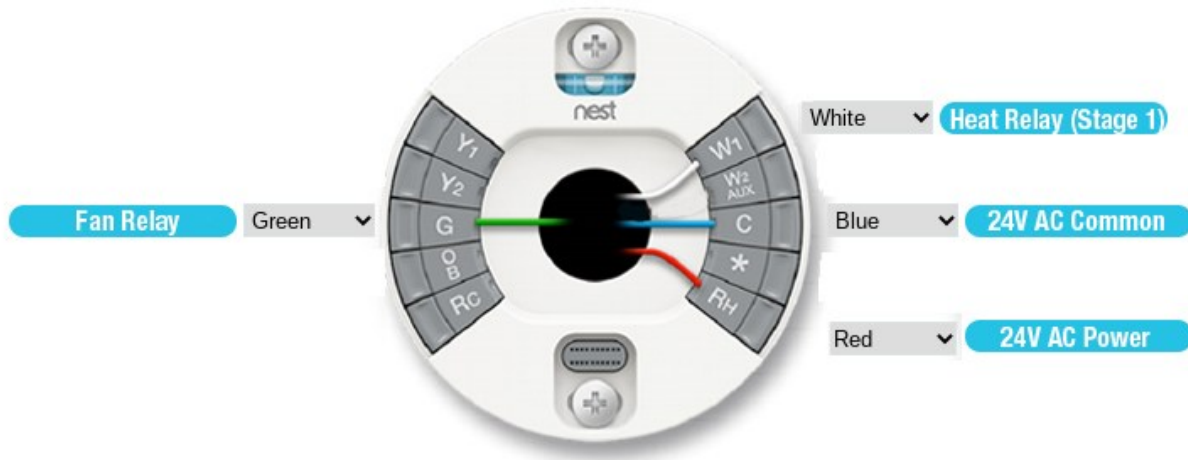

NOTES:

- Y1, Y2, O/B, R/C, & (*) are for Heat Pumps and Air Conditioning, NOT USED on KING HEATERS. The C wire keeps the Nest battery power charged.

CONNECTION OF OPTIONAL NEST BASIC / E THERMOSTAT

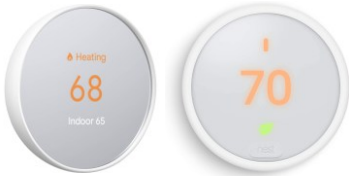

To connect a Nest / Nest E Series to PlatinumX, you will need to run multi-conductor thermostat wire between the Nest Learning Thermostat and the PlatinumX terminal board per the wiring diagram below. Thermostat wire is a class 2 power-limited circuit cable for use in thermostat control applications.

Nest King PlatinumX

G ----- G, FAN ONLY

W1 ----- W1, STAGE 1 HEAT

R ----- R, POWER (24VAC)

C ----- C, COMMON

Conventional 1 Stage Heating **PLATINUMX**

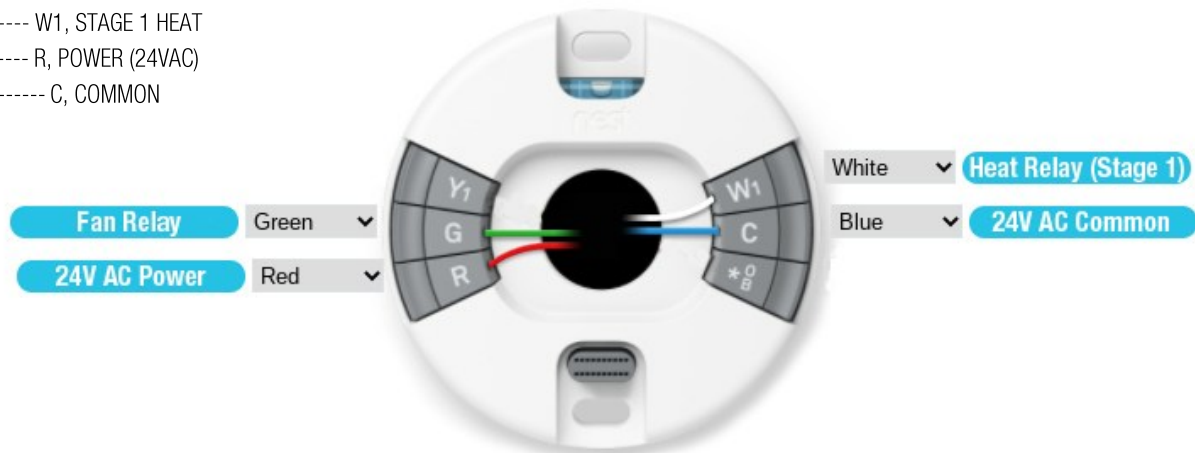

CONNECTION OF OPTIONAL ECOBEE THERMOSTAT



To connect a Ecobee to PlatinumX, you will need to run multi-conductor thermostat wire between Ecobee Thermostat and the PlatinumX terminal board per the wiring diagram below. Thermostat wire is a class 2 power-limited circuit cable for use in thermostat control applications.

Conventional 1 Stage Heating **PLATINUMX**

Ecobee King PlatinumX

- G ----- G, FAN ONLY
- W1 ----- W1, STAGE 1 HEAT
- RC ----- R, POWER (24VAC)
- C ----- C, COMMON

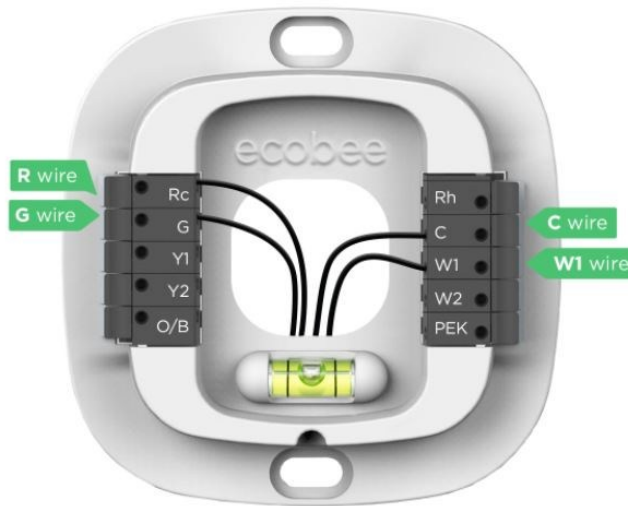

CONNECTION OF OPTIONAL HONEYWELL THERMOSTAT



Model: RTH9585WF1004

To connect a Honeywell model RTH9585WF1004 to PlatinumX, you will need to run multi-conductor thermostat wire between the Honeywell Thermostat and the PlatinumX terminal board per the wiring diagram below. Thermostat wire is a class 2 power-limited circuit cable for use in thermostat control applications.

Conventional 1 Stage Heating **PLATINUMX**

Honeywell King PlatinumX

- G -----G, FAN ONLY
- W-O/B ----- W1, STAGE 1 HEAT
- R ----- R, POWER (24VAC)
- C ----- C, COMMON

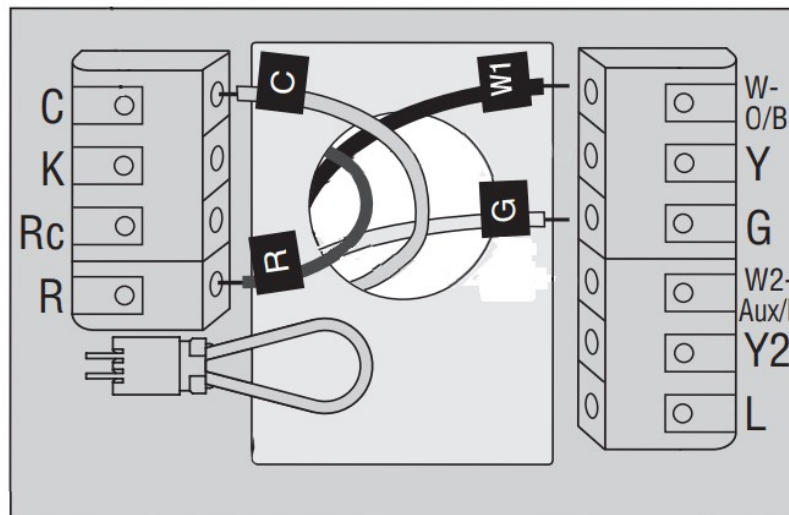

SAVE THESE INSTRUCTIONS

SMART LIMIT PROTECTION



Heater Safety Limit Tripped?

This heater is equipped with a thermal overload Smart Limit Protection which disconnects elements and motor in the event normal operating temperatures are exceeded. If thermal overload trips due to abnormal operating temperatures, thermal overload shall remain open until manually reset by turning the heater OFF for fifteen minutes. Inspect for any objects on or adjacent to the heater that may cause high temperatures. After inspecting the heater, keep the power to the heater off for 15 minutes to reset the SLP thermal protector. If the SLP thermal protector shuts the heater off again, immediately turn the heater OFF at the circuit breaker and inspect the heater for possible fan motor failure or dirt and lint on the heating element. Repeat the starting procedure.

MAINTENANCE

IMPORTANT: With proper care, your electric heater should last a lifetime. Therefore, seasonal cleaning is recommended to maintain the efficiency of the heater. Keep the heating elements, fan, and motor free of debris. Use compressed air to blow out any debris. Build-up of debris is a strong risk of fire.

WARNING: To prevent fire or explosion hazards, do not operate this heater in environments where combustible airborne particulates are present, especially if these particles can adhere to the heater and build up over time. This includes, but is not limited to: Woodworking areas with airborne sawdust; Food processing facilities with suspended cocoa powder, flour, or cornstarch; Grain storage or milling sites with grain dust.

We're Here to Help!

For any difficulties installing or operating this product

Call Us Toll Free at:

1-800-603-5464

7:00 am -3:30 pm PST Mon-Fri

Visit king-electric.com

or email us at tech@king-electric.com



Smart Heating Solutions